



2017-12-01

# Analysis of Safety Impacts of Access Management Alternatives Using the Surrogate Safety Assessment Model

Kyung Min Kim  
*Brigham Young University*

Follow this and additional works at: <https://scholarsarchive.byu.edu/etd>

 Part of the [Civil and Environmental Engineering Commons](#)

---

## BYU ScholarsArchive Citation

Kim, Kyung Min, "Analysis of Safety Impacts of Access Management Alternatives Using the Surrogate Safety Assessment Model" (2017). *All Theses and Dissertations*. 6629.  
<https://scholarsarchive.byu.edu/etd/6629>

This Thesis is brought to you for free and open access by BYU ScholarsArchive. It has been accepted for inclusion in All Theses and Dissertations by an authorized administrator of BYU ScholarsArchive. For more information, please contact [scholarsarchive@byu.edu](mailto:scholarsarchive@byu.edu), [ellen\\_amatangelo@byu.edu](mailto:ellen_amatangelo@byu.edu).

Analysis of Safety Impacts of Access Management Alternatives  
Using the Surrogate Safety Assessment Model

Kyung Min Kim

A thesis submitted to the faculty of  
Brigham Young University  
in partial fulfillment of the requirements for the degree of  
Master of Science

Mitsuru Saito, Chair  
Grant G. Schultz  
Dennis L. Eggett

Department of Civil and Environmental Engineering  
Brigham Young University

Copyright © 2017 Kyung Min Kim

All Rights Reserved

## ABSTRACT

### Analysis of Safety Impacts of Access Management Alternatives Using the Surrogate Safety Assessment Model

Kyung Min Kim

Department of Civil and Environmental Engineering, BYU  
Master of Science

In a traditional safety impact analysis, it is necessary to have crash data on existing roadway conditions in the field and a few years must pass before accumulating reliable crash data. This is a time-consuming approach and there remains uncertainty in the crash data due to the random nature of crash occurrences. The Surrogate Safety Assessment Model (SSAM) was developed for resolving these issues. With SSAM, a conflict analysis is performed in a simulated environment. A planned improvement alternative under study is modeled and no physical installation of the alternative is needed. Hence, the method using a simulation software along with SSAM consumes less time compared to other traditional safety analysis methods that may require a physical installation of the new alternative and a long wait time for data collection.

The purpose of this study is to evaluate if SSAM can be used to assess the safety of a highway segment or an intersection in term of the number and type of conflicts and to compare the safety effects of multiple access management alternatives with less time, less cost and less uncertainty than the traditional safety analysis methods. To meet the purpose of the study, two study sections, one on University Parkway in Orem and Provo and the other on Main Street in American Fork were selected and analyzed in this research.

Based on the findings from the calibration of SSAM on the University Parkway study section, an evaluation of the effect of converting a TWLTL median into a raised median on a section of Main Street (US-89) from 300 West to 500 East in American Fork was performed using SSAM working on VISSIM simulation's trajectory files of the study section. This evaluation study was conducted to show how SSAM could be used to evaluate the effect of access management alternatives using surrogate safety measures. The analysis showed that a raised median would be much safer than a TWLTL median for the same level of traffic volume. Approximately a 32 to 50 percent reduction in the number of crossing conflicts was achieved when a raised median was used in lieu of a TWLTL median at the Main Street study section.

Keywords: Access management, safety evaluation, conflict analysis, raised median, TWLTL, LiDAR, SSAM, VISSIM

## ACKNOWLEDGEMENTS

This research could not be completed without the assistance and advice of many people. I am grateful to the Utah Department of Transportation (UDOT) which provided the funding for this research. In addition, I appreciate the technical advisory committee for this research, especially Kevin Nichol of UDOT Research Project Manager and Tony Lau of Salt Lake City Airport Authority.

There have been great help and advice from faculty and students on the research team at Brigham Young University. I would like to express my gratitude to Dr. Mitsuru Saito, Dr. Grant G. Schultz, and Dr. Dennis L. Eggett for their guidance and assistance with this research. In addition, I would like to express my gratitude and friendship to Marlee Seat and Conor Seat who provided assistance with ArcMap 10.3.

I would also like to express my gratitude and love to my beloved family. They have always been my hope and future. My wife Hae Kim, my two sons Haram Kim and Uiram Kim have provided great support to finish this research. I was not able to start and finish it without them. In addition, I would like to express my gratitude to my father Sungjong Kim and Hyungsook Hong for their trust and support.

## TABLE OF CONTENTS

ABSTRACT .....	ii
TABLE OF CONTENTS.....	iv
LIST OF TABLES .....	vi
LIST OF FIGURES .....	vii
1 Introduction .....	1
1.1 Background and Need .....	2
1.2 Goal and Objectives.....	5
1.3 Organization of Reports .....	5
2 Literature review.....	7
2.1 Overview.....	7
2.2 TCT .....	7
2.2.1 TCT Development.....	8
2.2.2 TCT Procedure.....	10
2.3 SSAM.....	11
2.3.1 SSAM Development .....	11
2.3.2 SSAM Workflow.....	12
2.3.3 Definition of Surrogate Measures and Time Line of a Conflict Point Event .....	17
2.3.4 Use of SSAM in Previous Studies .....	23
2.4 Chapter Summary .....	33
3 Study Methodology .....	35
3.1 Methodology for Evaluating SSAM's Capabilities .....	35
3.2 Methodology for Using SSAM for Safety Evaluation of Different Median Alternatives .....	36
3.3 Chapter Summary.....	37
4 Data Preparation.....	39
4.1 Trip Generation .....	40
4.2 Trip Distribution and Traffic Assignment.....	40
4.3 Simulation Setup for the Main Street Study Section .....	41
4.4 Summary .....	45
5 Evaluation of SSAM's Capabilities .....	46
5.1 Results of Analysis.....	46
5.2 Summary .....	51

6	Application Of Ssam For Evaluating Safety Effects Of Two Different Median Treatments ...	53
6.1	Results of the Model Calibration .....	53
6.2	Use of SSAM to Evaluate Safety Impacts of Access Management Alternatives .....	58
6.3	Results of the Sensitivity Analysis.....	66
6.4	Summary .....	72
7	Conclusion .....	74
7.1	Summary of Literature Review .....	76
7.2	Findings from the Evaluation of the Capability of SSAM.....	76
7.3	Findings from a Sample Analysis of Safety Impacts of Two Access Management Alternatives using SSAM .....	77
7.4	Recommendations .....	78
	References.....	80
	Appendix A. Trip Distribution .....	84
	Appendix B. Spatial Analysis Results Of University Parkway .....	88
	Appendix C. Number Of Conflicts By Conflict Type Determined For Main Street Study Section.....	96
	Appendix D. Number Of Conflicts By Conflict Type Determined For Main Street Study Section...	101
	D.1 Rear-end Conflicts.....	101
	D.2 Lane-change Conflicts.....	103
	D.3 Total Conflicts .....	104

## LIST OF TABLES

Table 2-1: Description of the Selected VISSIM Model Parameters.....	33
Table 4-1: Trip Generation for Land Use on Main Street in American Fork.....	42
Table 5-1: Specification of Each Segment of the Calibration Study Site.....	46
Table 5-2: Numbers of Actual Crashes and Conflicts Identified by SSAM.....	49
Table 5-3: Relation Indices.....	49
Table 5-4: Statistical Analysis of Relation Indices.....	51
Table 6-1: Characteristics of Each Segment of the Study Section.....	55
Table 6-2: Number of Crash Data Record and Conflicts Points.....	54
Table 6-3: Relation Indices of the Two Segments.....	56
Table 6-4: ANOVA Test Results (Crossing Conflicts).....	68
Table 6-5: ANOVA Test Results (Rear-End Conflicts).....	69
Table 6-6: ANOVA Test Results (Lane-Change Conflicts).....	70

## LIST OF FIGURES

Figure 2-1: Traffic conflict criteria – left turn and weave conflicts .....	9
Figure 2-2: Traffic conflict criteria – cross-traffic conflicts and red-light violations.....	9
Figure 2-3: Traffic conflict criteria – rear-end conflicts .....	10
Figure 2-4: SSAM operational concept .....	13
Figure 2-5: SSAM user interface with case file defined.....	14
Figure 2-6: SSAM user interface with conflicts tab selected .....	15
Figure 2-7: SSAM user interface with summary tab selected .....	15
Figure 2-8: SSAM user interface with filter tab selected .....	16
Figure 2-9: SSAM user interface with map tab selected .....	17
Figure 2-10: Surrogate measures on conflict point diagram.....	17
Figure 2-11: Conflict types by angle .....	21
Figure 2-12: Lane-change conflict.....	21
Figure 3-1: Methodologies for University Parkway and Main Street Safety Analyses.....	38
Figure 4-1: VISSIM simulation model of the TWLTL median of Main Street .....	44
Figure 4-2: VISSIM simulation model of the raised median of Main St.....	44
Figure 5-1: University Parkway study site.....	47
Figure 5-2: Relation indices.....	49
Figure 5-3: Spatial analysis – Segment 1 of the University Parkway study section.....	50
Figure 6-1: Study site (Main Street between 300 West and 500 East in American Fork).....	55
Figure 6-2: Spatial analysis of Segment 1 of the Main Street study section .....	56
Figure 6-3: Spatial analysis of Segment 2 of the Main Street study section .....	57
Figure 6-4: Comparison of TWLTL and raised median for crossing conflicts .....	60
Figure 6-5: Three dimensional presentation of changes in the number of crossing conflicts .....	61
Figure 6-6: Top view of Figure 6-5 for crossing conflicts.....	61
Figure 6-7: Comparison of TWLTL and raise median for rear-end conflicts .....	62
Figure 6-8: Three dimensional presentation of changes in the number of rear-end conflicts .....	62
Figure 6-9: Top view of Figure 6-8 for rear-end conflicts.....	63
Figure 6-10: Comparison of TWLTL and raise median for lane-change conflicts .....	63
Figure 6-11: Three dimensional presentation of changes in the number of lane-change conflicts .....	64



Figure 6-12: Top view of Figure 6-11 for lane-change conflicts.....	64
Figure 6-13: Comparison of TWLTL and raise median for total number of conflicts .....	65
Figure 6-14: Three dimensional presentation of changes in total number of conflicts .....	65
Figure 6-15: Top view of Figure 6-14 for total number of conflicts .....	66
Figure 6-16: Threshold volume analysis results for TWLTL for crossing conflicts .....	71
Figure 6-17: Threshold volume analysis results for raised median for crossing conflicts .....	72

## 1 INTRODUCTION

This thesis presents the results of *Task 5: Perform Sensitivity Analysis using Surrogate Safety Assessment Model (SSAM)* of the parent project titled “Analysis of Access Management Impacts” (Schultz et al. 2017). Its goal is to provide the Utah Department of Transportation (UDOT) with a summary of the work performed to test whether SSAM could be used as a tool for evaluating the safety impact of access management alternatives. SSAM performs a conflict analysis of a highway or an intersection in a simulated environment and analyzes three types of potential conflicts for comparing the level of safety resulting from the installation of an access management alternative: crossing, rear-end, and lane-change conflicts.

The following is the description of Task 5 as it appears in the parent project:

*“[The Federal Highway Administration] FHWA provides and supports a wide range of data and safety analysis tools for State and local practitioners. The tools developed by FHWA are designed primarily to assist practitioners in understanding safety problems on their roadways. One tool that is available is the Surrogate Safety Assessment Model (SSAM), which is a tool for traffic engineers to perform comparative safety analysis of highway design alternatives using traffic simulation models. The software is free of charge and combines traffic microsimulation and automated conflict analysis and is designed to be compatible with a variety of simulation models, including VISSIM, Paramics, Aimsun, and TEXAS. SSAM uses the best possible surrogate measures that are observable in simulation models and supports flexible*

*analysis to provide different aggregations of statistics and different visualization types (FHWA 2015).”*

*“This project will utilize SSAM to perform a sensitivity analysis between volume, number of access points, and number of mainline traffic lanes, as well as an analysis of right turns and left turns into the major flow of traffic from the minor street. The model will utilize the VISSIM model as the base for the analysis. The research team will work closely with UDOT staff to identify existing models. Based on the availability of existing data, one (or more) corridors will be evaluated with the SSAM model to aid in analysis of the corridors.”*

The VISSIM 8.0 software was chosen to simulate the access management alternatives in this study and vehicle trajectory files were created using a feature available in the software. SSAM was then run on the vehicle trajectory files produced by VISSIM to perform a conflict analysis on vehicles’ positional data contained in the trajectory files.

This report presents the findings from the two studies: (a) Evaluation of SSAM’s capabilities using a segment of University Parkway between the interchange at I-15 in Orem and University Avenue in Provo and (b) Use of SSAM as a tool for evaluating safety impacts of replacing a two-way left-turn lane (TWLTL) with a raised median using a portion of Main Street (US-89) between 300 West and 500 East in American Fork. UDOT provided the base VISSIM models used for these analyses.

## **1.1 Background and Need**

The Access Management Manual defines access management as “the coordinated planning, regulation, and design of access between roadways and land development. It

encompasses a range of access management alternatives that promote the efficient and safe movement of people and goods by reducing conflicts on the roadway system and at its interface with other modes of travel. These access management alternatives include improvements to benefit transit, pedestrians, and bicyclists, as well as different treatments for urban, suburban, and rural settings” (Williams et al. 2014).

Several access management studies have been conducted by Brigham Young University (BYU) researchers with UDOT, including research on assessing the safety benefits of access management techniques (Schultz and Lewis 2006), a prioritization process for access management implementation (Schultz and Braley 2007), an analysis of crashes in the vicinity of major crossroads (Schultz et al. 2008), and research on the safety of raised medians (Schultz et al. 2010). One of the challenges with access management related studies had been the availability of necessary data for conducting such studies. However, UDOT began a Light Detection and Ranging (LiDAR) data inventory in 2012 that includes access locations along all the segments of UDOT’s highway network. The LiDAR program has continued and the LiDAR inventory was repeated in 2014 and 2015. Combined with UDOT’s crash data, the availability of access point data allowed BYU researchers to conduct in-depth safety-related studies to find relationships among access density, access management alternatives, and crash occurrences (Schultz et al. 2017).

Safety impacts of access management alternatives can be analyzed using before-and-after studies. However, in a traditional safety impact analysis it is necessary to install an access management alternative in the field and a few years must pass before reliable crash data accumulate. It is a time-consuming study and there remains uncertainty in the crash data due to the random nature of crash occurrences. Another method is a conflict analysis done in the field.

This analysis is not affected by the randomness in crash occurrence but the access management alternative must be installed to conduct the analysis and one must wait for several months before conducting a conflict analysis. Often, a conflict analysis of a proposed access management alternative at a certain site is performed at a segment of a highway that has similar characteristics to the one where the planned access management alternative would be placed. The traditional conflict analysis in the field may become time consuming and costly if the same segment where a new access management alternative is planned must be analyzed. If a location with similar traffic characteristics and a similar physical layout is studied to evaluate the effect of the new access management alternative under study for a highway segment, it is not an ideal comparison because there are no two highway segments with the same traffic and physical characteristics. Hence, there has been a need for a safety analysis method that will overcome these issues.

SSAM was developed for the purpose of resolving the problems described in the previous paragraph. With SSAM, a conflict analysis is performed in a simulated environment; hence, the physical and traffic characteristics of before and after the installation of an access management alternative can be maintained for before and after analyses. With this method, a planned access management alternative under study is added in a simulation model and no physical installation of the alternative is needed in the field; thus, it is not costly. It is based on a conflict analysis; hence, it is not affected by randomness and uncertainty inherent to the method that uses crash data. In addition, it is not time consuming like other traditional safety analysis methods because physical installation and observation of the new alternatives are not required.

## 1.2 Goal and Objectives

The goal of this study was to evaluate if SSAM, a free software program based on a conflict analysis concept, developed by the Federal Highway Administration (FHWA) could be used to assess the safety effect of an access management alternative and to compare the safety effects of multiple access management alternatives with less time, less cost and less uncertainty. To meet the goal of the study the following objectives were set:

1. Identify the capability of SSAM through a literature review and compare its conflict-analysis-based safety analysis method with traditional safety analysis methods using historical crash data,
2. Locate study sites to test SSAM, given a list of potential study locations for which VISSIM models have been developed by UDOT,
3. Evaluate spatial and frequency relationships between the conflict points determined by SSAM and the observed crashes at the studied highway sections to determine if UDOT engineers can use SSAM as a tool to conduct safety analyses of access management alternatives, and
4. Apply SSAM for evaluating safety implications of selected access management alternatives once the result of the third objective indicates such studies can be done by SSAM.

## 1.3 Organization of Reports

This report consists of following chapters. Chapter 1 presented an overview of the report along with a background and the objectives of the study. Chapter 2 presents the literature review with an emphasis on the findings from previous studies on SSAM. Chapter 3 describes the study

methodology by which SSAM's usefulness in safety analysis of access management alternatives is tested. Chapter 4 contains the data preparation carried out to test SSAM at two study sites. Chapter 5 reports the findings from the application of SSAM to a segment of University Parkway from the I-15/University Parkway interchange in Orem to the intersection between University Parkway and University Avenue in Provo, which contains various types of median treatments. Chapter 6 discusses the findings from the analysis of a segment of Main Street (US 89) between 300 West and 500 East in American Fork. Chapter 7 contains conclusions and recommendations regarding the use of SSAM for safety impact analyses.

## 2 LITERATURE REVIEW

### 2.1 Overview

In this section, a summary of the literature review on traffic safety analysis methods conducted in the study is presented. Crash data on existing roadways are an ideal source for evaluating traffic safety of highway segments under study. However, safety analyses using traffic crash records have often suffered from the problems associated with the reliability issue of crash data and the time required to wait for the number of crashes to accumulate to reach targeted sample sizes to meet the rigor of statistical analyses. For these reasons, other methods using surrogate measures have been developed. One of them is the Traffic Conflicts Technique (TCT) and the other is SSAM. The literature review for this study focuses on these two safety analysis methods.

### 2.2 TCT

Since reliable crash data may not always be available, traffic safety engineers have proposed various surrogate safety measures for safety assessment. TCT is one of the techniques that use surrogate safety assessment measures. This section provides information on TCT development and the TCT procedure.



### 2.2.1 TCT Development

The General Motors Research Laboratories (GMRL) originally developed the TCT in 1967 (Glennon and Thorson 1975). TCT was performed in the field by observing and measuring crash potential on existing traffic facilities. Crash potential is defined as a conflict event, which is the occurrence of evasive vehicular actions and characterized by braking and weaving maneuvers forced by an impending collision or a traffic violation. Traffic violations are recorded as conflicts regardless of the presence of other vehicles.

Five basic conflict categories were defined by GMRL including left-turn, weave, cross-traffic, red-light violation, and rear-end conflicts. A left-turn conflict is defined by a situation where a left-turn vehicle crosses directly in front of an opposing through vehicle causing the through vehicle to brake or weave. A weave conflict occurs when a vehicle changes lanes into the path of another vehicle, causing the offended vehicle to brake or weave to avoid an impending collision. A cross-traffic conflict is defined by a situation where a vehicle crosses or turns into the path of a through right-of-way vehicle, causing the through vehicle to brake or weave. A red-light-violation conflict occurs when a vehicle enters the intersection and crosses the curb line on a red signal. A rear-end conflict is defined by a situation where two vehicles are traveling as a pair and the first vehicle stops or slows unexpectedly as viewed by the following driver. The second vehicle is forced to take an evasive action by braking or changing lanes. A rear-end conflict can be initiated by a previous traffic conflict. In this case, both the initiating conflict and the rear-end conflict are recorded. Figure 2-1 through Figure 2-3 show illustrations of TCT traffic conflict criteria (Glennon and Thorson 1975).

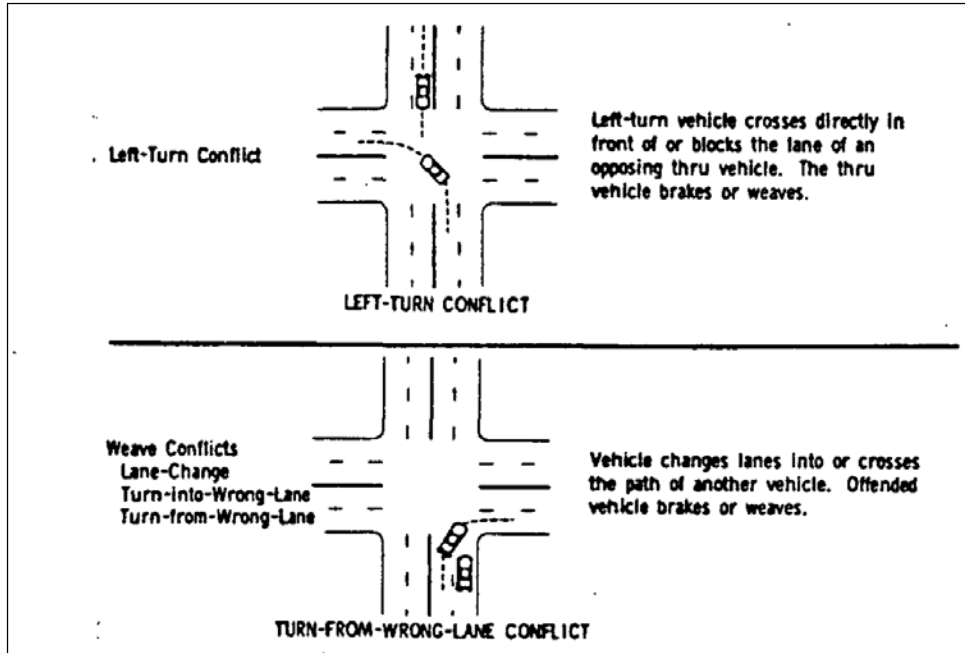


Figure 2-1: Traffic conflict criteria – left turn and weave conflicts(Glennon and Thorson 1975)

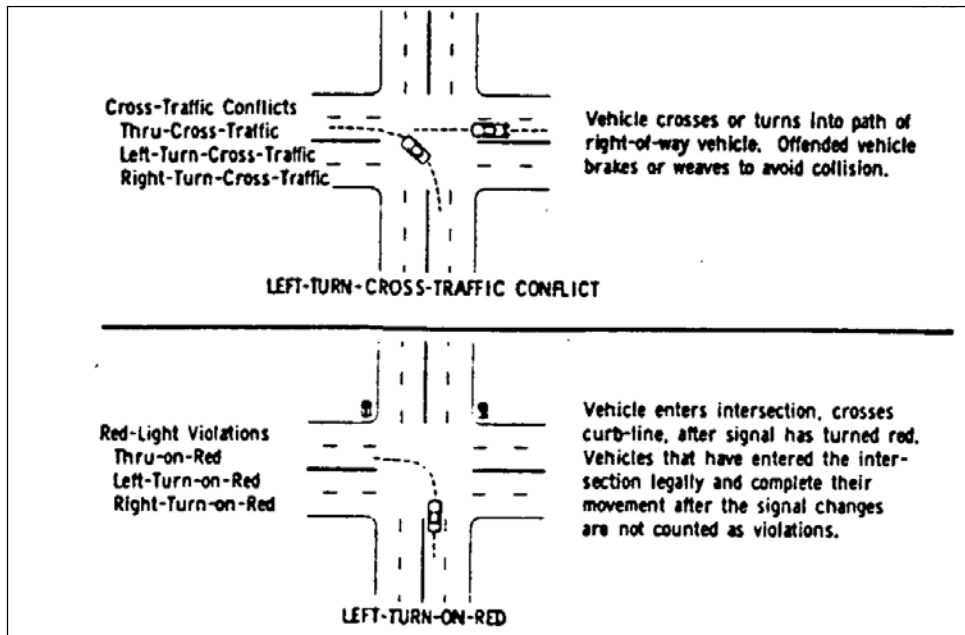


Figure 2-2: Traffic conflict criteria – cross-traffic conflicts and red-light violations(Glennon and Thorson 1975)

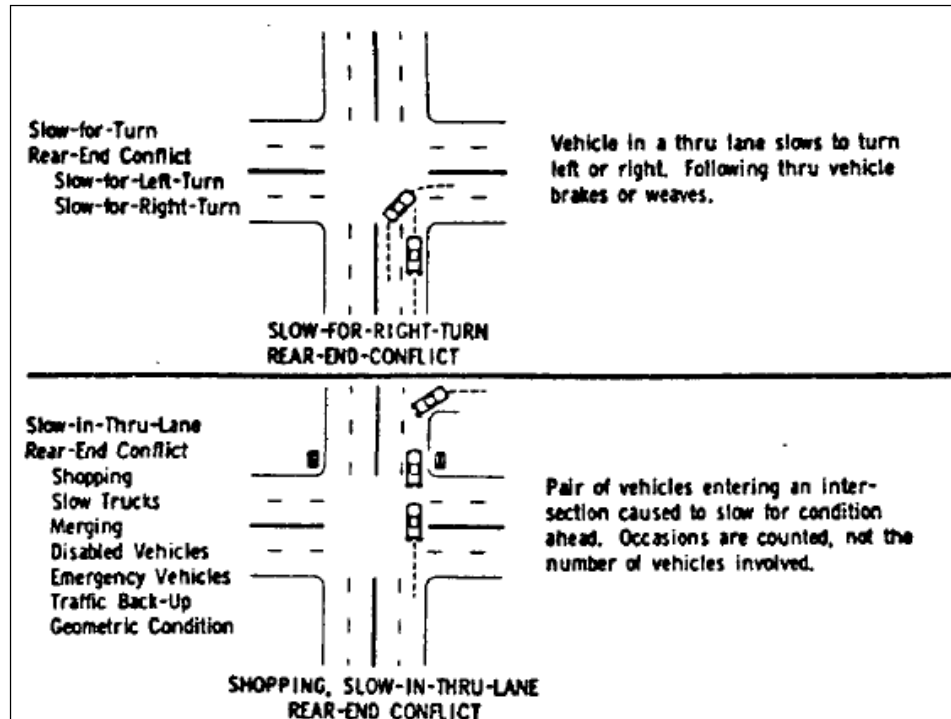


Figure 2-3: Traffic conflict criteria – rear-end conflicts (Glennon and Thorson 1975)

## 2.2.2 TCT Procedure

The major tasks of the TCT analysis include field data collection based on traffic conflict criteria specified by GMRL, counting all numbers of conflicts for each facility, and a statistical analysis performed to determine the relationships between conflicts and crashes. According to Baker (Baker 1971), the results of their study using the TCT analysis are the following:

1. The statistical analysis conducted in the study supports the hypothesis that conflicts and crashes are associated.
2. Safety deficiencies at intersections can be pinpointed more quickly and reliably using the TCT than using a safety method that uses crash data.
3. The TCT may be particularly valuable at low-volume rural intersections where the crash reporting level is low.

4. The TCT, because of its usefulness in pinpointing intersection problems more precisely, should lead to lower-cost remedial actions.
5. The TCT can be applied with minor modifications to locations other than intersections.
6. The effect of intersection improvements may be demonstrated from conflict counts taken shortly after the completion of a “spot improvement” type change.
7. The general surveillance information obtained during conflict counts may be valuable in improving the overall operation of intersections.

The TCT has some strengths and limitations compared to the safety analysis based on actual crash records on specific facilities. Although the TCT analysis is free from the problems associated with the reliability issues of crash records and requires much less time for accumulating adequate sample sizes of crashes compared to the safety analysis method based on actual crash records, it still requires an existing facility that has enough traffic volume so that an adequate number of conflicts can be observed (Glennon and Thorson 1975).

## 2.3 SSAM

SSAM is another method that uses surrogate safety measures for safety assessment. It is a post-processor of vehicle trajectory files produced by microscopic traffic simulation models. This section provides a general description of SSAM including its development, workflow, surrogate measures, and a summary of the use of SSAM in previous studies.

### 2.3.1 SSAM Development

Transportation professionals have used microscopic traffic simulation extensively for many years to evaluate and compare the operational performance of design alternatives.

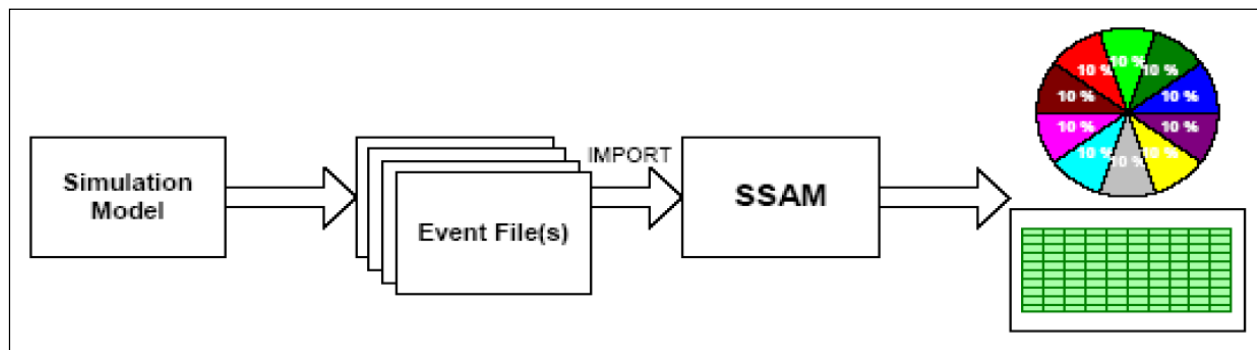
Recently, there has been an interest in expanding the use of traffic simulation to safety assessment. The SSAM approach was proposed by a research team at SIEMENS and was sponsored by the FHWA. In 2003, Gettman and Head studied the potential for deriving surrogate safety measures from commonly available microscopic traffic simulation models, and their efforts eventually led to the development of the SSAM (Gettman and Head 2003).

Before SSAM was used in practical engineering applications, research was needed to evaluate the validity of using simulated conflicts for safety assessment. Using crash data reported at 83 four-leg urban signalized intersections, Gettman et al. (2008) studied the relationship between simulated conflicts and actual crashes that took place at the studied intersections. A crash prediction model was developed as part of the study to relate the simulated conflicts to the actual crashes reported at selected intersections. The authors found that there was a significant relationship between the simulated conflicts and crashes. In a more recent study conducted in the Netherlands, a 300-km<sup>2</sup> road network was modeled using the software Paramics (Dijkstra et al. 2010). The researchers collected six years of crash data from 569 pre-selected intersections in the road network. Generalized linear regression models were developed to predict crash frequency using the number of simulated conflicts as a variable. The study concluded that there was a significant statistical relationship between the observed crashes and the simulated conflicts (Dijkstra et al. 2010).

### **2.3.2 SSAM Workflow**

SSAM operates by processing data describing the trajectories of vehicles driving through a simulated traffic facility (e.g., a signalized intersection) and identifying conflicts. The vehicle trajectory input data for SSAM can be generated by traffic simulation software programs

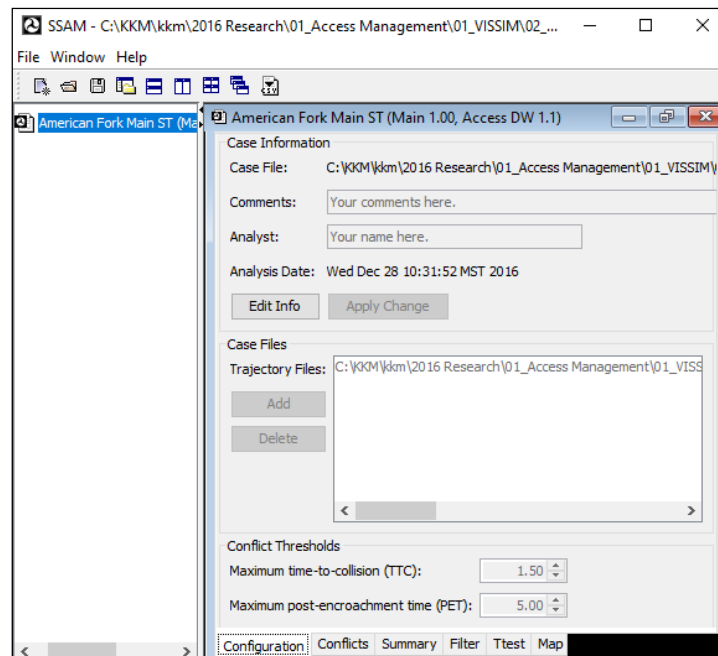
including VISSIM, Aimsun, Paramics, and TEXAS in a trajectory file format (where files are labeled with a .trj file extension) specifically designed for SSAM. SSAM calculates surrogate measures of safety corresponding to each vehicle-to-vehicle interaction and determines whether or not each interaction satisfies the criteria to be deemed an official conflict. A table of all identified conflicts and their corresponding surrogate safety measures is then presented to the user. Figure 2-4 illustrates the workflow for using SSAM (Sabra et al. 2010)



**Figure 2-4: SSAM operational concept (Sabra et al. 2010)**

The user begins the analysis by first enabling output of vehicle interaction (trajectory) data in the simulation model of his or her choice. The user then runs the simulation model for a number of iterations—replications with alternate random number seeds—to obtain a statistically sufficient set of simulation output data. The user then launches the standalone SSAM application using the trajectory files as input. The user defines a new conflict analysis case by using the menus to create a new case file, or alternatively, to open an existing case file. Figure 2-5 shows a case document where various views of its corresponding input and output data are organized in a multi-tabbed format. The software uses two threshold values for surrogate measures of safety to delineate which vehicle-to-vehicle interactions are classified as conflicts. These two thresholds are applied to the values Time-To-Collision (TTC) and Post-Encroachment Time (PET). The

software provides default threshold values for these measures, which the user may override with his or her preferred alternate values. SSAM uses a default TTC value of 1.5 seconds, as suggested in previous research studies (Gettman and Head 2003). Once the conflict identification thresholds are determined, the user processes the trajectory data to identify vehicle-to-vehicle interactions that satisfy the conflict classification criteria. Each conflict identified during analysis, including data from the trajectory files of all corresponding replications of the simulation, is listed with conflict details under the conflicts tab, which is shown in the right-hand pane in Figure 2-5, including the time, location, and all surrogate measures of safety for that conflict. SSAM also provides a Summary screen for each case, as shown in Figure 2-6. The user clicks the summary tab to switch from the conflict table to a view of summary statistics as shown in Figure 2-7. Summary statistics include the number of different conflict types for each simulation replication, as well as the average and total values over all replications. Additionally, average values of proposed surrogate measures are presented in the summary (Sabra et al. 2010).



**Figure 2-5: SSAM user interface with case file defined**

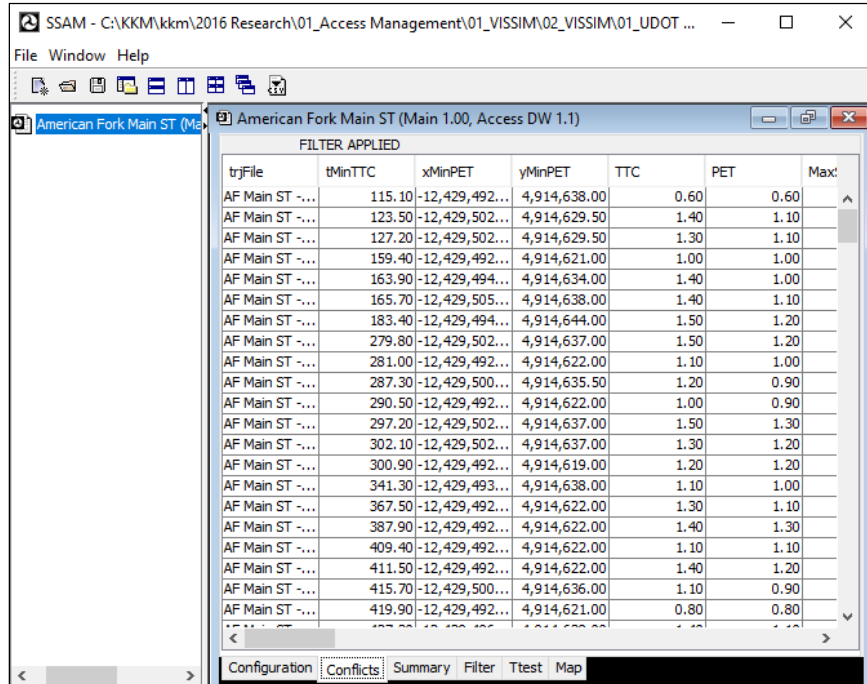


Figure 2-6: SSAM user interface with conflicts tab selected

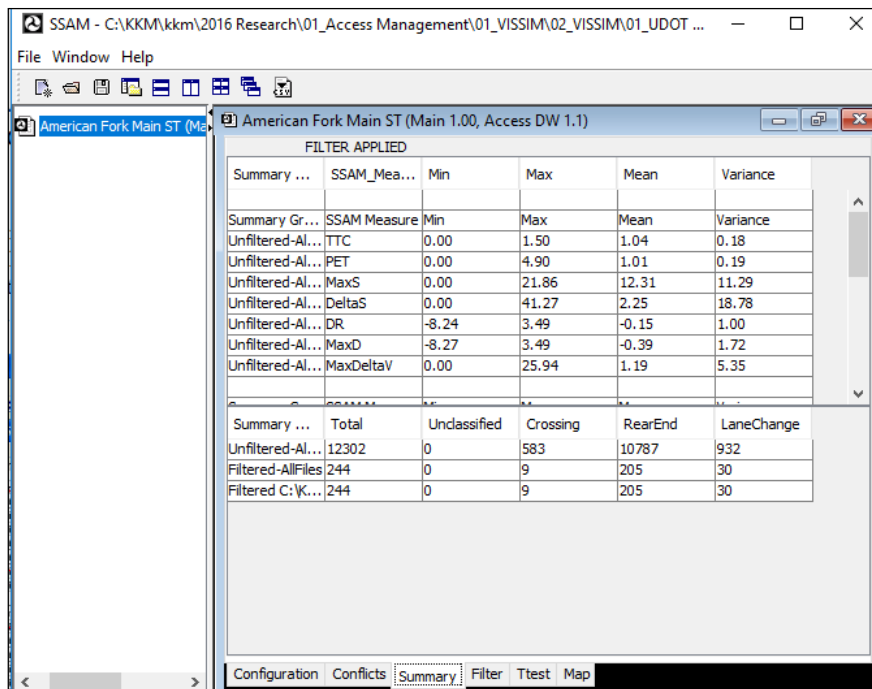


Figure 2-7: SSAM user interface with summary tab selected

SSAM also includes a Filter tool, shown in Figure 2-8, which can be accessed via the Filter tab of the case display. By configuring filter parameters, the user can effectively instruct



the software to do filtering that mimics a question such as “Show me all rear-end conflict events where the speed differential was greater than 40.25 km/h (25 mi/h) occurring in lane 5 of link 12.” Once the filter is applied, only those conflicts satisfying the filter criteria appear in the conflict table, and the summary statistics are recomputed for this subset of the conflicts. In addition, SSAM features two additional screens that also appear as tabs on the user interface. These additional screens are a Map panel and a t-test panel. As shown in Figure 2-9, the Map panel allows a user to display a map or image of the underlying roadway network and overlay conflicts on that map. The map display can be exported to an image file to facilitate report generation. In addition, the t-test panel can be used to calculate statistical properties of the conflict data to facilitate comparisons between type scenarios (Gettman et al. 2008).

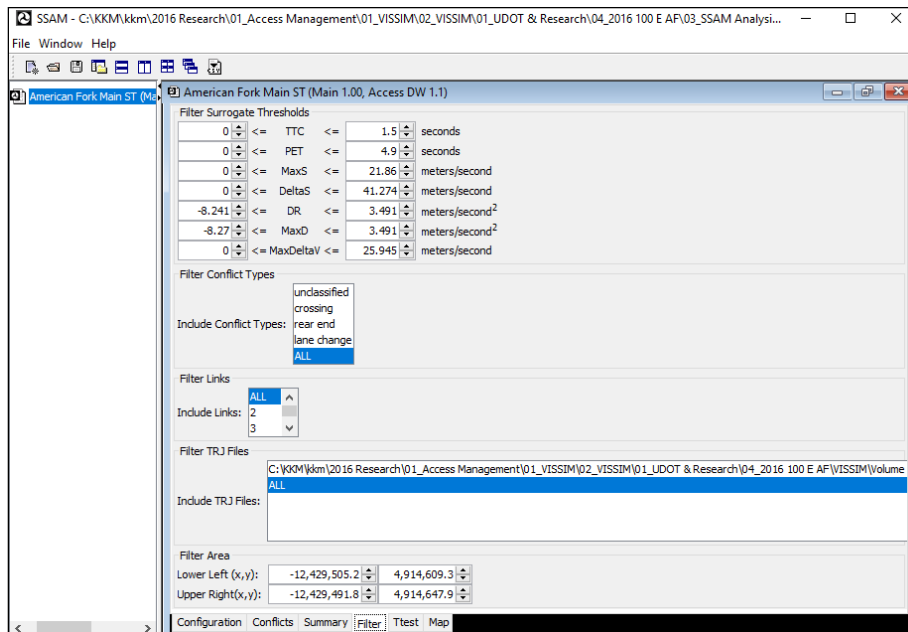


Figure 2-8: SSAM user interface with filter tab selected

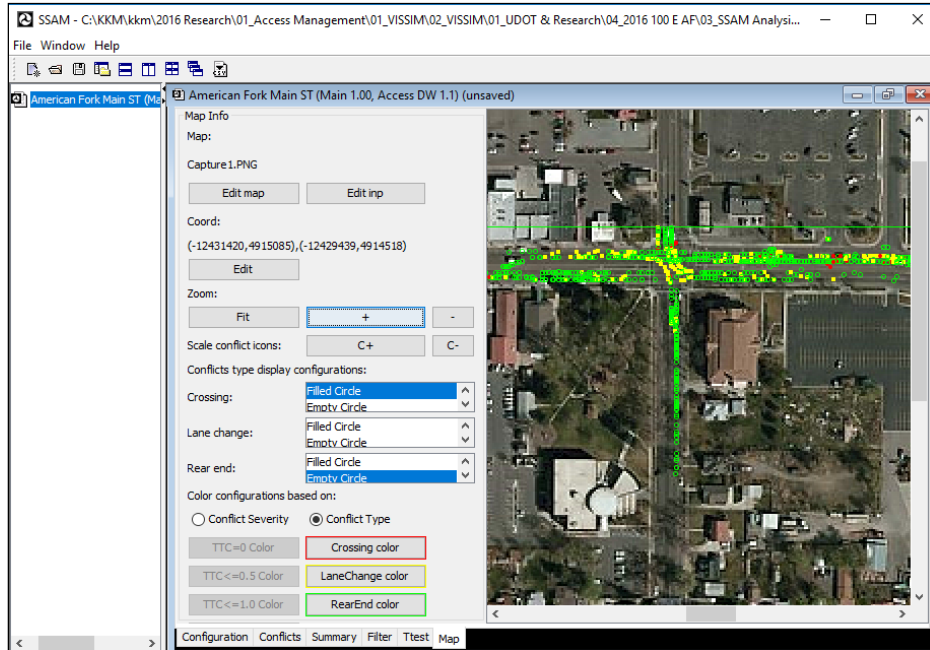


Figure 2-9: SSAM user interface with map tab selected

### 2.3.3 Definition of Surrogate Measures and Time Line of a Conflict Point Event

SSAM's user manual defines several surrogate safety measures, which are shown in Figure 2-10 and defined in this section (Sabra et al. 2010).

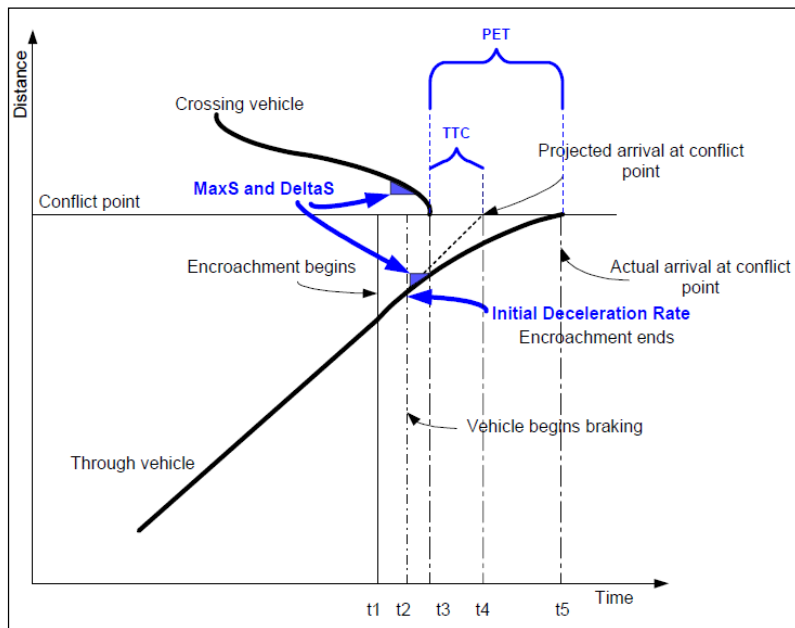


Figure 2-10: Surrogate measures on conflict point diagram (Gettman and Head 2012)

- TTC is the minimum time-to-collision value observed during the conflict. This estimate is based on the current location, speed, and future trajectory of two vehicles at a given instant. A TTC value is defined for each time-step during the conflict event. A conflict event is concluded after the TTC value rises back above the critical threshold value. This value is recorded in seconds.
- PET is the minimum post-encroachment time observed during the conflict. PET is the time between when the first vehicle last occupied a position and the time when the second vehicle subsequently arrived at the same position. A value of zero indicates a collision. PET is associated with each time-step during a conflict. A conflict event is concluded when the final PET value is recorded at the last location where a TTC value was still below the critical threshold value. This value is recorded in seconds.
- MaxS is the maximum speed of either vehicle throughout the conflict (i.e., while the TTC is less than the specified threshold). This value is expressed in feet per second or meters per second, depending on the units specified in the corresponding trajectory file.
- DeltaS is the difference in vehicle speeds as observed at  $t_{\text{MinTTC}}$  which is the simulation time when the minimum TTC value occurs. More precisely, this value is mathematically defined as the magnitude of the difference in vehicle velocities (or trajectories), such that if  $v_1$  and  $v_2$  are the velocity vectors of the first and second vehicles respectively, then  $\text{DeltaS} = \|v_1 - v_2\|$ . For context, consider an example where both vehicles are traveling at the same speed,  $v$ . If they are traveling in the same direction,  $\text{DeltaS} = 0$  (zero). If they have a perpendicular

crossing path,  $\Delta S = (\sqrt{2}) * v$ . If they are approaching each other head on,  $\Delta S = 2 * v$ .

- DR is the initial deceleration rate of the second vehicle, recorded as the instantaneous acceleration rate. If the vehicle brakes (i.e., reacts), this is the first negative acceleration value observed during the conflict. If the vehicle does not decelerate, this is the lowest acceleration value observed during the conflict. This value is expressed in feet per second or meters per second, depending on the units specified in the corresponding trajectory file.
- MaxD is the maximum deceleration of the second vehicle, recorded as the minimum instantaneous acceleration rate observed during the conflict. A negative value indicates deceleration (braking or release of gas pedal). A positive value indicates that the vehicle did not decelerate during the conflict. This value is expressed in feet per second or meters per second, depending on the units specified in the corresponding trajectory file.
- ConflictType, as shown in Figure 2-11, describes whether the conflict is the result of a rear-end, lane-change, or crossing movement. If link and lane information is not available for both vehicles, then the event type is classified based solely on the absolute value of the ConflictAngle. The type is classified as a rear-end conflict if  $||\text{ConflictAngle}|| < 30$  degrees, a crossing conflict if  $||\text{ConflictAngle}|| > 85$  degrees, or otherwise a lane-change conflict. The simulation model that produces the vehicle trajectory data can generally provide link and lane information for both vehicles, though the coding of these values may vary significantly from one simulation vendor to the next. If link and lane information

are available, that information is used for classification in the case that the vehicles both occupy the same lane of the same link at either the start or end of the conflict event. If the vehicles both occupy the same lane at the start and end of the event, then it is classified as a rear-end event. If either vehicle ends the conflict event in a different lane than it started without having changed links, then the event is classified as a lane-change conflict. If either of the vehicles changes links over the course of the event, then the conflict angle determines the classification as previously described, with the following possible exception. For two vehicles that begin the conflict event in the same lane, as shown in Figure 2-12, but change links over the course of the event, the classification logic considers only rear-end or lane-change types, based on the conflict angle and using the threshold value previously mentioned. Note that vehicle maneuvers such as changing lanes into an adjacent turn-bay lane or entering into an intersection area may be considered changing links, depending on the underlying simulation model. In some cases, vehicles that appear to be traveling in the same lane may actually be considered by the simulation model as traveling on different links that happen to overlap.

- MaxDeltaV is the maximum velocity difference between two vehicles (DeltaV) in the conflict.
- FirstDeltaV (SecondDeltaV) is the change between conflict velocity (given by speed FirstVMinTTC and heading FirstHeading) and the post collision velocity (given by speed PostCrashV and heading PostCrashHeading). This is a surrogate

for the severity of the conflict, calculated assuming a hypothetical collision of the two vehicles in the conflict.

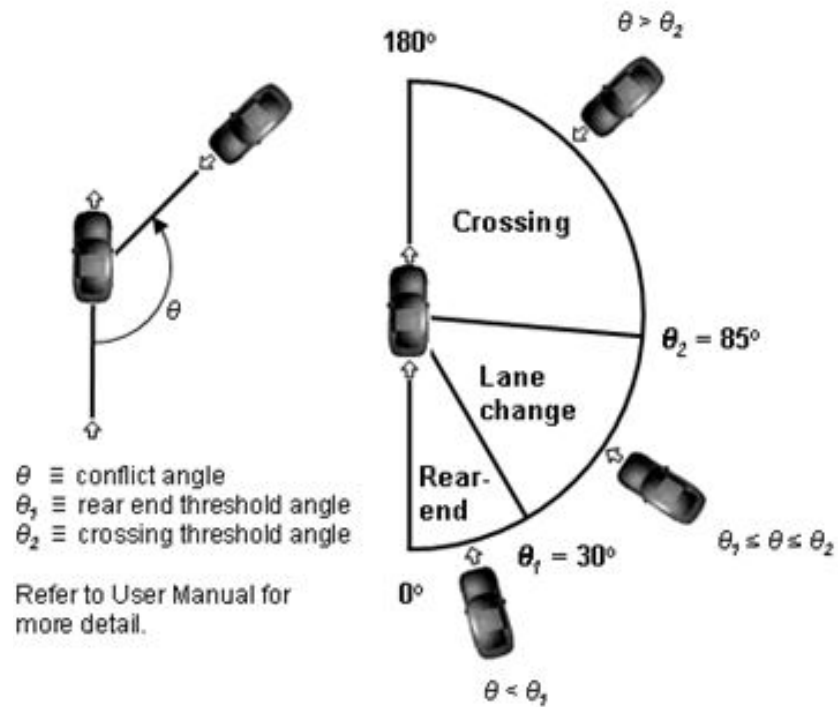


Figure 2-11: Conflict types by angle (Sabra et al. 2010)

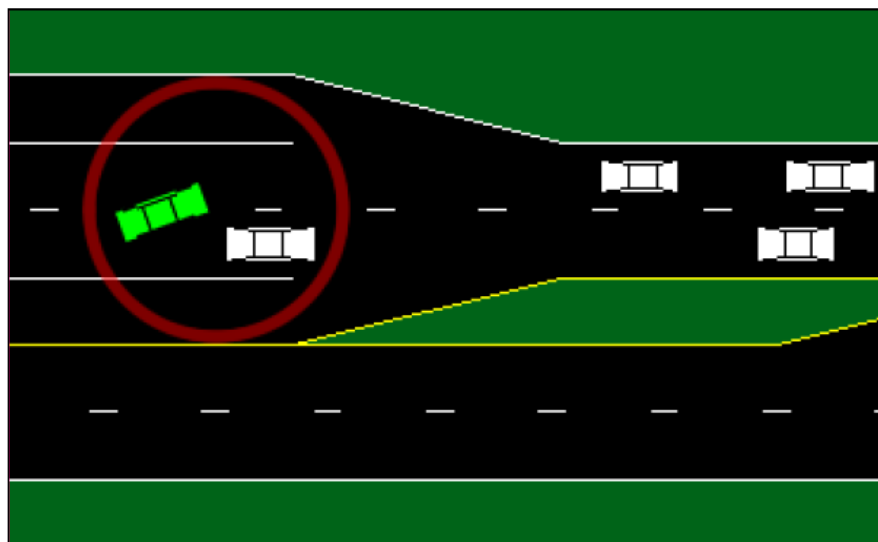


Figure 2-12: Lane-change conflict (Sabra et al. 2010)

The time line of a conflict point event was illustrated previously in Figure 2-10. The top curve represents the time-space trajectory of the crossing vehicle. The bottom curve represents the time-space trajectory of the through vehicle. While these curves are shown as continuous, smooth functions in the figure, the vehicle time-space trajectories are actually a set of straight lines between time steps in a traffic simulation. As the number of time steps per second increases, the curves become closer approximations to a smooth curve (assuming the update equations and functions used by the traffic simulation are applicable at any time step resolution).

The times  $t_1$  through  $t_5$  are defined as follows (Sabra et al. 2010):

- At time  $t_1$ , the crossing vehicle enters the encroachment area (i.e., starts to turn left).
- At time  $t_2$ , the through vehicle realizes that a collision might occur and begins braking to avoid the collision.
- At time  $t_3$ , the corner of the rear bumper (either right or left rear corner, depending on the travel direction) of the crossing vehicle leaves the encroachment point.
- At time  $t_4$ , the through vehicle is projected to arrive at the conflict point if the vehicle continued at the same speed and trajectory before it started braking.
- At time  $t_5$ , the through vehicle actually arrives at the conflict point.

Conflict points also occur at the intersection of a flow from a right- or left-turning vehicle that proceeds in the same direction as the conflicted vehicle, but in a different lane. This situation can only be evaluated in simulations where the entering path can vary by lane. For example, in the real world, many maneuvers of this type occur on purpose by drivers who want to accept a particular gap of the size required to enter the flow, but that gap size was not available in the

closest lane, because of the acceleration needed by the entering vehicle to avoid an approaching vehicle in that lane. A smaller gap could be accepted, however, if the entering vehicle crosses in front of the approaching vehicle and begins accelerating in the adjacent lane assuming that no vehicle is approaching in the adjacent lane, or the approaching vehicle in the adjacent lane is farther away. Thus, a conflict point event can occur when the driver crosses the first lane to enter the second one and begins accelerating. This occurs even if the driver then re-enters the crossed lane after the approaching vehicle has passed (Gettman and Head 2012).

#### **2.3.4 Use of SSAM in Previous Studies**

SSAM has been used in various traffic safety studies. In this section, a summary of publications that helped the BYU team to learn further the strengths and weaknesses of SSAM is presented.

In the SSAM and Validation study, Gettman et al. (2008) assessed the capabilities of SSAM by conducting a theoretical validation, field validation, and sensitivity analysis. Eleven “theoretical” validation tests were performed to compare the surrogate, safety assessment results of pairs of simulated design alternatives. In addition, a field validation exercise was conducted to compare the output from SSAM with real-world crash data. Eighty-three intersections from British Columbia, Canada were modeled in VISSM and simulated under AM-peak traffic conditions. The processed conflict results were then compared with the crash data in a number of different statistical validation tests. Lastly, sensitivity analysis was performed to identify differences between the SSAM-related outputs of each simulation model vendor’s system on the same traffic facility designs. These comparative analyses provide some guidance to the relative use of surrogate measures data from each simulation system (Gettman et al. 2008).



In the theoretical validation, Gettman et al. (2008) found that under equivalent traffic conditions (e.g., traffic volumes and turning percentages), for both intersection and interchange design alternatives analyzed in their study, SSAM could discern statistically significant differences in the total number of conflicts, the number of conflicts by type (i.e., crossing, lane-change, or rear-end conflicts), and conflict severity indicators (e.g., average TTC, PET, Delta-V values). However, the authors reported that in most cases the comparison of the two alternatives did not reveal a clearly preferable design but rather a trade-off of surrogate safety measures. It was typical, for example, that one design exhibited a higher frequency of conflicts, but those conflicts exhibited lower severity ratings than the other alternative design. The authors expressed concern that this type of assessment outcome would hinder unequivocal decision-making about which design would be the safer of the two.

Gettman et al. (2008) reported that the field validation showed that the simulation-based intersection conflicts data provided by SSAM were significantly correlated with the actual crash data collected in the field, with the exception, in particular, of conflicts during path-crossing maneuvers, which were under-represented in the simulation. The relationship between total number of conflicts and total number of crashes exhibited an  $R^2$  value of 0.41, which is consistent with the typical performance reported in several studies using traditional crash prediction models of urban, signalized intersections. However, the authors noted that the traditional (volume-based) crash prediction models were better correlated with the crash data than the surrogate measures from SSAM in all test cases. For example, Average Daily Traffic (ADT)-based crash prediction models exhibited an  $R^2$  value of 0.68 with actual crash frequencies.

Gettman et al. (2008) also reported that a fairly wide range of results could be obtained from applying different simulation models to the same traffic facility designs. In general, intersections modeled in VISSIM exhibited the fewest total conflicts, and intersections modeled in TEXAS had the highest conflict frequency—approximately 10 times higher than VISSIM. Conflict totals from Aimsun and Paramics fell between these two extremes. The authors reported that the abnormally high number of conflicts in TEXAS seemed to stem from the explicit inclusion of active conflict avoidance in the driver behavior model of TEXAS, whereas other simulations employ more reactive driver behavior modeling. An example of reactive behavior reported in the study manifested in the form of particularly extreme braking and deceleration events in the Aimsun and Paramics simulations. In all of the simulation programs, rear-end conflicts made up the bulk of the total conflicts at all evaluated TTC thresholds (0.5s, 1.0s, and 1.5s). They reported that this bias persisted even after eliminating low-speed events from the analysis (i.e., events occurring at speeds less than 16.1 km/h (10 mi/h) were excluded). There were no major differences in the average TTC values across the models, although Aimsun and Paramics did exhibit higher average deceleration rates (DR) and lower PET, consistent with their relatively reactive driver behavior modeling. In general, the traffic performance measures such as throughput and delay vary and are vaguely comparable from all systems under light traffic; however, the differences in the default driving behaviors and modeling assumptions produce pronounced differences in simulation results at higher volume levels. In addition, SSAM identified questionable scenarios in all simulation programs where vehicles were driving directly through one another (i.e., crashes or conflicts with a TTC of 0).

Hummer et al. (2010) evaluated operational, safety, and perceived effects of superstreets, called “restricted crossing U-turn intersections” by FHWA, and developed a level of service

estimation program which could be used on North Carolina's urban and rural arterial roadway system. The operational analysis involved calibrating and validating VISSIM models of three existing signalized superstreets in North Carolina – two isolated intersections, and one five-intersection superstreet corridor. Results from the three models were compared to the results from the simulation models of equivalent conventional intersections at various volume levels using travel time as the main measure of effectiveness. The superstreet outperformed the conventional intersection at each location studied, reducing the overall average travel time per vehicle traveling through the intersection. The safety analysis involved three separate methods – naïve, comparison-group, and Empirical Bayes. Only unsignalized superstreets were analyzed using the Empirical Bayes method. Three signalized superstreets were evaluated using SSAM. Hammer et al. (2010) reported that the results from the analyses were inconclusive with signalized superstreets. Unsignalized superstreets, however, showed a significant reduction in total, angle and right turn, and left turn collisions in all analyses. The analysis also showed a significant reduction in fatal and injury collisions.

Al-Ghandour et al. (2011) studied conflict patterns at single-lane roundabouts with and without slip lanes and compared their performances by VISSIM and SSAM. From a sensitivity analysis of several volume distribution scenarios of the percentage of turning traffic, five zone-based conflict prediction models were developed with Poisson regression. The models captured simulated conflict differences that resulted from the addition of a right-turn slip lane. The models were evaluated under three exit control scenarios (yield, stop, and free-flow merge). The SSAM's conflict analysis showed that the models predicted the occurrence of conflicts for roundabout zones with different  $R^2$  values, which ranged from 0.69 to 0.97. The models were compared with national and international crash prediction models for single-lane roundabouts

and were further validated by actual crash data from 10 single-lane roundabouts in the city of Carmel, Indiana. The number of conflicts for a single-lane roundabout was predicted as a function of approach entry, circulation, and slip lane traffic flows and it was determined to be sensitive to the type of slip lane exit. The SSAM analysis showed that conflicts in the merge area were more frequent than in the roundabout approach area and that the installation of a free-flow slip-lane exit type reduced overall conflict occurrence. The results demonstrated the usefulness of SSAM analysis for evaluating roundabout safety and developing an empirical relationship between simulated conflicts and field-observed crashes.

Lee et al. (2011) investigated safety aspects of the Cooperative Vehicle Infrastructure System (CVIS)-based urban traffic control system by applying SSAM. The purpose of this study was to assess whether safety has been affected and, if so, how much safety has been compromised due to reduced time headways between vehicles and higher acceleration or deceleration rates under the CVIS-based urban traffic control system. A simulation-based case study was performed on a hypothetical arterial that consisted of four intersections with four traffic congestion cases covering high to low volume conditions. As a result, the CVIS control, when compared to the coordinated actuated control, reduced the average values of TTC and PET by 0.69 and 1.94 seconds, respectively. Note that shorter TTC and PET indicate a more dangerous situation. However, they reported that the number of rear-end conflict events decreased by 58 percent under the CVIS-based control, indicating safer driving conditions could be achieved with the CVIS-based control system.

Huang et al. (2012) conducted a study to identify if the VISSIM simulation model combined with SSAM could provide reasonable estimates of traffic conflicts that might take place at signalized intersections. A total of 80 hours of traffic data and traffic conflicts data were

collected at 10 signalized intersections. Simulated conflicts generated by the VISSIM simulation model and identified by SSAM were compared with the traffic conflicts measured in the field. Of particular interest of the study was to identify if the consistency between the simulated and the observed conflicts could be improved by calibrating VISSIM simulation models and adjusting threshold values used for defining simulated conflicts in SSAM. A two-stage procedure was proposed in this study to calibrate and validate the VISSIM simulation models. The authors reported that the two-stage calibration procedure improved the goodness-of-fit between the simulated conflicts and the real-world conflicts. Linear regression models were developed to study the relationship between the simulated conflicts and the observed conflicts. The authors reported that results of data analysis showed that there was a reasonable goodness-of-fit between the simulated and the observed rear-end and total conflicts. However, the authors found that the simulated conflicts were not good indicators for the traffic conflicts generated by unexpected driving maneuvers such as illegal lane-changes in the real world. The authors further tested the prediction performance of the conflict prediction models using the simulated conflicts as independent variables and found that the conflict prediction models provided acceptable prediction performance for the total and the rear-end conflicts with the Mean Absolute Percent Error (MAPE) – to measure the differences between the observed and the simulated conflicts – value of 18 percent and 20 percent, respectively. However, they reported that the prediction performance of the conflict prediction models for the crossing and the lane change conflicts was only moderate with a MAPE value of 31 percent and 38 percent, respectively.

Stevanovic et al. (2012) proposed a new approach to integrating VISSIM, SSAM, and the VISSIM-based Genetic Algorithm for Optimization of Signal Timings (VISGAOST) for optimizing signal timings to reduce surrogate safety measures and thereby reduce risks of

potential real-world crashes. In addition, a multi-objective genetic algorithm was implemented into VISGAOST to identify the optimal compromise between two competing objectives: improved safety and traffic efficiency. A 12-intersection corridor on Glades Road in Boca Raton served as a case study. The authors reported that optimized signal timings delivered a solution that balanced both safety and efficiency. When compared to initial signal timings, the estimated number of conflicts was reduced by 7 percent. In addition, when compared to signal timings optimized for efficiency, the estimated number of conflicts was reduced by 9 percent without a significant loss of efficiency (about 1 percent). The study also approximated a Pareto Front of conflicts and throughput, which may be instrumental when trading off surrogate safety for efficiency in the development of signal timing plans.

Zhou and Huang (2013) used simulated conflicts to pre-evaluate the safety performance of signalized intersections. A signalized intersection was simulated in VISSIM and its vehicle trajectory files were analyzed by SSAM to identify simulated conflicts. Simulated conflicts were then compared with the traffic conflicts measured in the field, and a two-stage calibration procedure (traffic simulation and SSAM analysis) was carried out to improve the goodness-of fit between these two conflict data sets. After calibration and validation of the existing condition, the remedial measure for this intersection, reducing the speed limit from 60 km/h to 50 km/h, was simulated in VISSIM. Comparison of the simulated conflicts under different speed limits showed that the safety performance of this intersection was improved after reducing the speed limit.

Habtemichael and Santos (2014) quantitatively evaluated the safety implications of aggressive driving (speeding, following closely and weaving through traffic) using a microscopic traffic simulation approach. A combination of VISSIM and SSAM was used to model the studied

motorway and assess the safety implications of aggressive driving. The use of vehicle conflicts was validated by correlating the results of SSAM analyses to observed crashes. Crash risk, severity levels and the magnitude of the perceived benefits of aggressive driving were quantified relative to normal drivers under congested and uncongested scenarios. Involvement in vehicle conflicts was used to determine crash-risk while reductions in PET and travel time were used to determine the severity levels of the expected crashes and the magnitude of the perceived benefits. The results indicated that the crash risk of aggressive drivers was found to be in the range of 3.1 to 5.8 times that of normal drivers, depending on traffic conditions and type of road aggression. PET of the conflicts involving aggressive drivers reduced by 7 to 61 percent compared to normal drivers, indicating high severity levels of the expected crashes. Moreover, the magnitude of the perceived benefit in terms of reduction in travel time was found to be as little as 1 to 2 percent. The study concluded that aggressive driving would entail a significant safety risk while the benefits of aggressive driving are actually very minor.

So et al. (2014) adopted an integrated simulation approach for generating more realistic vehicle trajectories, ultimately for enhancing the surrogate safety assessment methodology under the Connected Vehicle (CV) environment. This integrated simulation is divided into two main parts, real time-based simulation approach and post-processing approach. The real-time simulation environment consists of the microscopic traffic simulator to generate various traffic situations, driver-warning simulator, Global Positioning System(GPS)/Inertial Navigation Unit (INU) simulator, and vehicle-to-vehicle(V2V)/vehicle-to-infrastructure(V2I) communication delays probability model. INU measures accelerations and orientation rates of a moving object using motion sensors and rotation sensors. The post-processing approach includes a vehicle dynamics model to incorporate vehicle dynamics to the vehicle trajectories and SSAM to

identify vehicle conflicts. This integrated simulation approach was adopted to assess the safety impact of CV-based traffic applications by considering potential positioning errors and communication delays which are likely to occur in reality. The evaluation results showed that the V2V/V2I communication delays degraded the effectiveness of driver warnings by 3 to 13 percent while the driver warnings under ideal conditions (i.e., error-free vehicle positions and no V2V/V2I communication delays) reduced conflicts by 27 to 42 percent. In addition, the most accurate GPS/INU device (i.e., Real-Time Kinematic (RTK) GPS) was the best for use with vehicle safety applications as the RTK case was the closest to the ground truth-based warning scenario. Meanwhile, the device with the lowest accuracy (i.e., autonomous GPS) was not very suitable for deployment in the safety application as this case showed even worse results than the base case (i.e., no driver warnings). The integrated simulation approach used for these experiments is a practical and reliable alternative for assessing the safety impact of CV-based traffic applications. It considers the potential positioning errors and communication delays, which are likely to affect the performance of CV-based traffic applications in reality and uses vehicle dynamics-incorporated vehicle trajectories, which are more realistic than the mere traffic simulator vehicle trajectories.

Vasconcelos et al. (2014) also validated SSAM for assessing intersection safety. The specific goal of this research was to validate SSAM as a tool for crash prediction at urban intersections. Two methods were used for validation. The first method compared the simulated number of conflicts from SSAM and the predicted number of injury crashes from analytic models in three reference intersection layouts (four-leg priority intersection, four-leg staggered intersection, and single-lane roundabout). The second method compared SSAM results with conflicts observed on site at four real intersections: two four-leg priority intersections and two



roundabouts. The results indicated that, despite some limitations related to the nature of current traffic microsimulation models, SSAM would be a promising tool for assessing the safety of new facilities or innovative layouts because it does not require the installation of such plans in the field.

Essa and Sayed (2015) investigated the transferability of calibrated parameters of the traffic simulation model (VISSIM) for safety analysis between different sites. The main purpose of this study was to examine whether the calibrated parameters, when applied to other sites, give reasonable results in terms of the correlation between the field-measured and the simulated conflicts. Eighty-three hours of video data from two signalized intersections in Surrey, British Columbia were used in this study. Automated video-based computer-vision techniques were used to extract vehicle trajectories and identify field-measured rear-end conflicts. Calibrated VISSIM parameter values obtained from the first intersection that maximized the correlation between simulated and field-observed conflicts were used to estimate traffic conflicts at the second intersection. This experiment then compared the results with the parameter values optimized specifically for the second intersection. The authors reported that the VISSIM parameter values were generally transferable between the two locations as the transferred parameter values provided better correlation between simulated and field-measured conflicts than using the default VISSIM parameters. Six VISSIM parameters, as shown in Table 2-1, are identified as important for the safety analysis. Two parameters such as CC1 and desired deceleration were directly transferable, three parameters such as CC0, reduction factor for safety distance closed to stop line, and start upstream of stop line were transferable to some degree, and parameters such as CC4 and CC5 were not transferable at all.

**Table 2-1: Description of the Selected VISSIM Model Parameters (Essa and Sayed 2015)**

Parameter	Description	Unit	Default
CC0	Standstill distance: the desired distance between stopped vehicles. This distance does not have variation through all the simulated vehicles.	m	1.50
CC1	Headway time: the time that a driver wants to keep. The higher the value, the more cautious the driver is. Thus, at a given speed $v$ [m/s], the safety distance [m] is computed to equal $(CC0 + CC1 \cdot v)$	s	0.9
CC4 & CC5	Following thresholds: the thresholds which control the speed differences during the 'Following' state (In VISSIM, there are four driving modes: free driving, approaching, following, and braking). Smaller values of (CC4 & CC5) result in a more sensitive reaction of drivers to accelerations or decelerations of the preceding car, i.e. the vehicles are more tightly coupled. CC4 and CC5 are used for negative and positive speed differences, respectively.	-	$\pm 0.35$
Reduction factor for safetytd:paraenterdistance closed to stop line	This reduction factor defines the vehicle behavior close to stop line at signalized intersections. This reduction factor is applied to the vehicle's desired safety distance within a specific section started upstream the stop line and ended downstream the stop line. The specific distances upstream and downstream the stop line are predefined by the user.	-	0.60
Start upstream of stop line	Distance upstream of the stop line of signalized intersection. Within this distance, the reduction factor is applied to the vehicle's desired safety distance.	m	100
Desired deceleration	Desired deceleration is used as the maximum for the followings parameters: the deceleration caused by a desired speed decision; the deceleration in case of Stop & Go traffic, when closing up to a preceding vehicle; the deceleration toward an emergency stop position (route); and for co-operative braking.	m/s <sup>2</sup>	-2.80

Chai and Wong (2015) conducted a study to compare two simulation methods for estimating conflicts between road users. An improved cellular automata (CA) model was proposed to estimate the occurrences and severity of traffic conflicts (both vehicle–vehicle and vehicle–pedestrian) at signalized intersections. The authors compared the proposed CA model with a calibrated method of SSAM based on VISSIM. Simulated conflicts from both methods were compared with observed vehicle conflicts from automated vehicle tracking for both occurrences and severity. Simulation results showed that the CA approach was able to replicate realistic conflicts. However, they reported that SSAM tended to overestimate occurrences and underestimate the severity of rear-end and lane-change conflicts. SSAM was also found to overestimate the severity of crossing conflicts. An added benefit of the proposed CA model was that it was able to estimate conflicts between vehicles and pedestrians.

## 2.4 Chapter Summary

Two methods using surrogate safety measures were introduced in this chapter. One is TCT and the other is SSAM. Although TCT is free from the reliability issues of using actual crash records and requires much less time for accumulating necessary data for analysis, it still

requires existing facilities that have enough traffic volume for producing a large enough number of conflicts for meaningful analyses. On the other hand, the method using SSAM combines microsimulation and an automated conflict analysis, which analyzes the frequency and character of narrowly averted vehicle-to-vehicle collisions in traffic. SSAM allows the user to assess the safety of traffic facilities without actually installing improvement alternatives and it does not require a long wait time for accumulating the necessary amount of data to be analyzed. Hence, analysis time is dramatically reduced. Since SSAM was provided by FHWA in 2003, many validation and application studies have been performed. Although some studies have indicated that some overestimated number of conflicts were observed in the process, this literature review suggests that SSAM can be a viable tool to evaluate and compare safety effects of planned safety improvements on roadways and intersections.

### 3 STUDY METHODOLOGY

Chapter 3 presents the methodology used to evaluate SSAM's capabilities as well as the methodology for using SSAM for safety evaluation of different median alternatives.

#### 3.1 Methodology for Evaluating SSAM's Capabilities

To evaluate the capabilities of SSAM, a VISSIM simulation model of a 4.3-mile segment of the University Parkway corridor between the I-15 interchange in Orem and University Avenue in Provo was used. The VISSIM model was run for a period of 75 minutes, which was the length of the analysis period of the VISSIM model of University Parkway provided by UDOT. VISSIM creates a trajectory file for each simulation run, which keeps track of locations of each vehicle as it moves through the simulated system. Ten simulation runs were made for this evaluation study. Then, SSAM was run using the trajectory files created by VISSIM as input to analyze vehicles in adjacent positions to identify whether they have the potential for crossing, rear-end, or lane-change conflict using a set of conflict classification logics discussed in Section 2.3.1. The threshold values used for maximum TTC and maximum PET in this study were 1.5 seconds and 5.0 seconds respectively, which are the default values used by SSAM as outlined by Sabra et al. (2010).

The simulated section of University Parkway was divided into seven segments to improve the comparison of the results from the SSAM analysis with the five-year crash data

available for this section because of the differences in annual average daily traffic (AADT) along the study section. The focus of the analysis was to find a general relationship between the potential occurrence of conflicts in a simulated environment and the actual crash occurrences, both in frequency and location.

### **3.2 Methodology for Using SSAM for Safety Evaluation of Different Median Alternatives**

Once the evaluation of SSAM using a section of University Parkway explained in Section 3.1 indicated that SSAM could be used to evaluate a trend in crash occurrence and location, a test site was chosen to evaluate if SSAM can be used as a tool to compare the safety effects of access management alternatives. The access management alternatives compared in this study are a TWLTL median and a raised median. A section on Main Street (US-89) between 300 West and 500 East in American Fork is used because a 75-minute VISSIM model for this section was available from UDOT and it currently has a TWLTL median. The VISSIM model provided by UDOT did not contain all the access driveways in the model. Hence, potential trips from all 74 access driveways from the land uses along the study section were added to the simulation model using the 8th Edition of the Institute of Transportation Engineers (ITE) Trip Generation Manual (ITE 2008). A more detailed description of data preparation for the study section is presented in Chapter 4.

To make certain that the results will be reliable, the VISSIM model was calibrated using SSAM in the same way it was calibrated for the University Parkway study section with 10 simulation runs. The results of conflict frequencies and locations of the three types of conflicts were compared with the actual crashes from the five-year crash data from year 2010 to 2014.

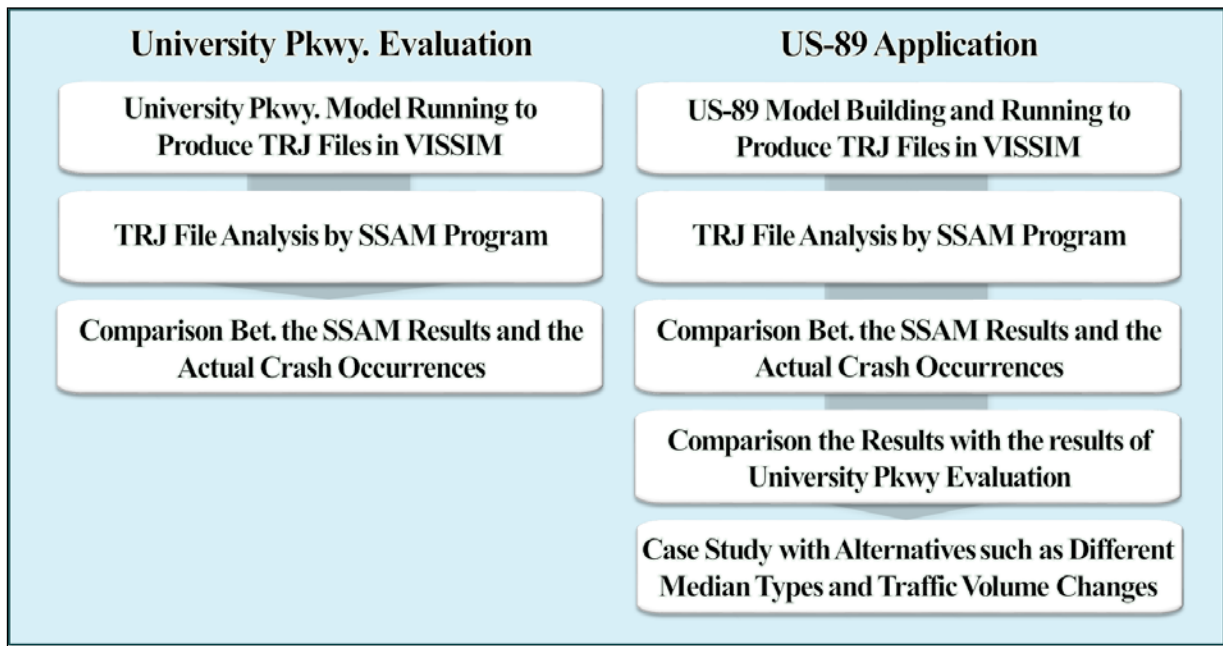
After the calibration work, the safety effects of the two types of access management alternatives,

that is, a TWLTL median and a raised median, were evaluated. In order to evaluate the effects of these access management alternatives in the mid-block, access driveways to all the business and other establishments were added to the original VISSIM model provided by UDOT. In the second part of the task, a sensitivity analysis was conducted to identify a threshold AADT to convert a TWLTL median into a raised median. For this analysis, the traffic volumes of Main Street and the access roads (driveways) to the land uses along the segment were increased at a 10 percent increments up to a 40 percent increase. A preliminary analysis showed that beyond the 40 percent increase in volume the VISSIM model began having vehicle entry problems. Hence, five levels of Main Street volume and five levels of access driveway volume are modeled for each access management alternative from 1.0 to 1.4 with an increment of 0.1 (10 percent increase). A total of 25 combinations of traffic volumes are simulated for each alternative, totaling 50 combinations. Due to this large number of simulation combinations, each case was simulated three times instead of 10 times. The goal was to investigate a general trend in the way conflict frequency would increase or decrease when a TWLTL median is replaced with a raised median.

### 3.3 Chapter Summary

Two evaluation analyses were performed to test the capability of SSAM. The first analysis used a section of University Parkway from I-15 interchange in Orem to University Avenue in Provo to evaluate if SSAM could be used a surrogate safety analysis tool by comparing location and frequency of conflicts resulting from the SSAM analysis and the location and frequency of actual crashes. Once the results of the first analysis indicated that SSAM would be useful for safety analyses, the second analysis was performed. The second analysis used a section of Main Street (US-89) from 300 West to 500 East in American Fork to determine if

SSAM could be used to evaluate the safety effects of different access management alternatives, such as TWLTL median and a raised median. A sensitivity analysis was used to identify the threshold traffic volumes for these two access management alternatives. Figure 3-1 shows the workflow of these two analyses.



**Figure 3-1: Methodologies for University Parkway and Main Street Safety Analyses**

## 4 DATA PREPARATION

This chapter presents the data preparation task involved in conducting an evaluation study for the section of Main Street (US-89) between 300 West and 500 East in American Fork, the results of which are presented in Chapter 6. Since the VISSIM model of the University Parkway study section provided by UDOT is very similar to the existing access condition along the University Parkway and the purpose of the analysis did not require details of land use along the study section, the original model given by UDOT did not require special updates for the evaluation study. The original simulation model for the Main Street study section in American Fork given by UDOT, however, contained only major signalized intersections along the study section. It did not include access driveways and their traffic demand along the study section. Therefore, the model needed modifications to include all of the driveways along the study section because to test the safety effects of access management alternatives, demands from each of these driveways is important. In this chapter, the steps taken to prepare trip demand data to achieve the objective of the second evaluation study are summarized. The 8th Edition of the ITE Trip Generation Manual (ITE 2008) was used to estimate trips generated by all the land uses along the study section. The steps explained in this chapter follow three of the four steps of the classical urban traffic demand forecasting method: trip generation, trip distribution, and traffic assignment. In addition, the simulation setup for the model is presented.



#### 4.1 Trip Generation

In the trip generation step, traffic volumes (number of trips) were generated for the existing land uses along the study section using the 8th Edition of the ITE Trip Generation Manual (ITE 2008). Table 4-1 presents 95 land uses found along the study section with their land use Code names, ITE codes, and PM peak traffic volumes. Since the PM peak period was modeled in VISSIM, the average trip rate for weekday PM peak hour was estimated and then multiplied by the area of each land use to get total trips generated. Next, the trips were divided into entering and exiting trips based on the directional distribution rate provided in the 8th Edition of the ITE Trip Generation Manual. The first land use listed in Table 4-1, Emission Plus, is used to explain this process. The store has 1,661- ft<sup>2</sup> floor space. Its trip generation rate for the evening peak is 4.01 trips/1,000 ft<sup>2</sup>. This results in  $1,661 \text{ ft}^2 \times 4.01 \text{ trip/hour}/1,000 \text{ ft}^2 = 7 \text{ veh/hour}$ . The directional distribution is given as 51 percent entering, 49 percent exiting, resulting in 4 veh/hour entering and 3 veh/hour exiting, rounded to whole numbers to represent the number of vehicles as shown in the first data row of Table 4-1.

#### 4.2 Trip Distribution and Traffic Assignment

Because traffic volumes and vehicle compositions in traffic volume on Main Street were given in the original VISSIM model provided by UDOT, the mode split step was omitted. In the trip distribution step, all the entering and exiting traffic volumes on each land use needed to be distributed to the trip origin or destination in the simulation model. All the trips for each land use estimated from the trip generation step were considered entering and exiting from the through traffic volume on Main Street of the study section since the total traffic volume on Main Street cannot be changed. For the sensitivity analysis presented in Section 6.1.2, the traffic volume was increased at 10 percent increments from the original volume from 10 percent, 20 percent, 30

percent, and finally to 40 percent of the original traffic volume on Main Street and access driveways. A complete list of trip distribution values for all the land uses along the study section can be found in Appendix A.

After the trip distribution step, all entering and exiting trips were assigned to each access driveway. In the TWLTL case, all entering and exiting trips from each access driveway were assigned to each starting end of eastbound and westbound links on Main Street study section. It was assumed that the trips that make a left turn to enter an access driveway or exit from an access driveway in the TWLTL case, would use the TWLTL median on Main Street. Alternately, in the case of the raised medians, the trips that make a left turn using the TWLTL median in the TWLTL case would use the nearest signalized intersection downstream to make a U-turn to complete their trips to their destinations such as an access driveway or the east or west ends of Main Street.

#### **4.3 Simulation Setup for the Main Street Study Section**

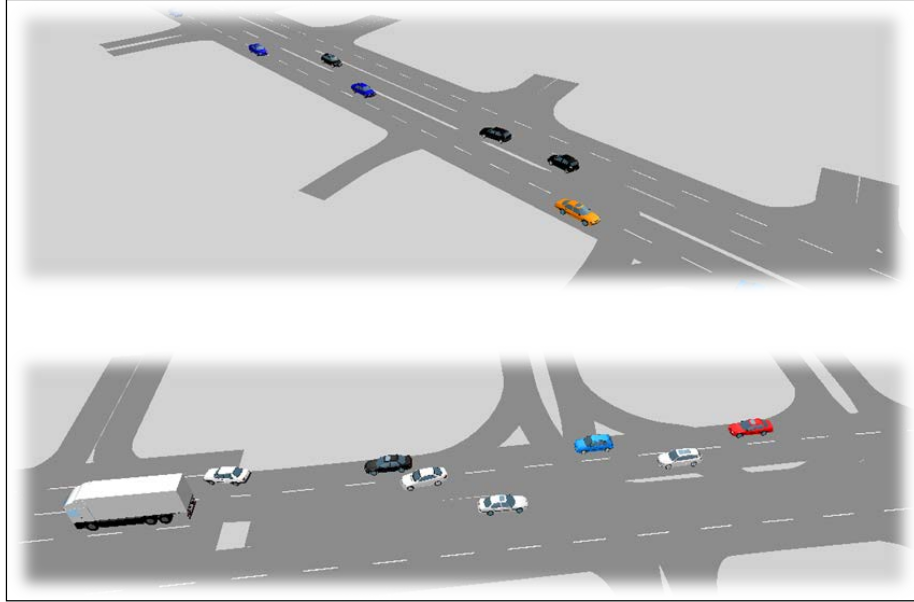
After the trip assignment step for all the land uses along the study section was completed, entry and exit volumes were entered in the driveway links to prepare the model for a sensitivity analysis of changing demand volumes. In total, for the two median types (TWLTL and raised median), 150 traffic simulation runs were made (5 volume levels for Main Street x 5 volume levels for the driveways x 3 replications for each combination x 2 median types = 150 simulation runs). Figure 4-1 shows screen shots of the TWLTL simulation model and Figure 4-2 shows screen shots of the raised median simulation model. Each simulation model was run for 75 simulation minutes.

**Table 4-1: Trip Generation for Land Use on Main Street in American Fork**

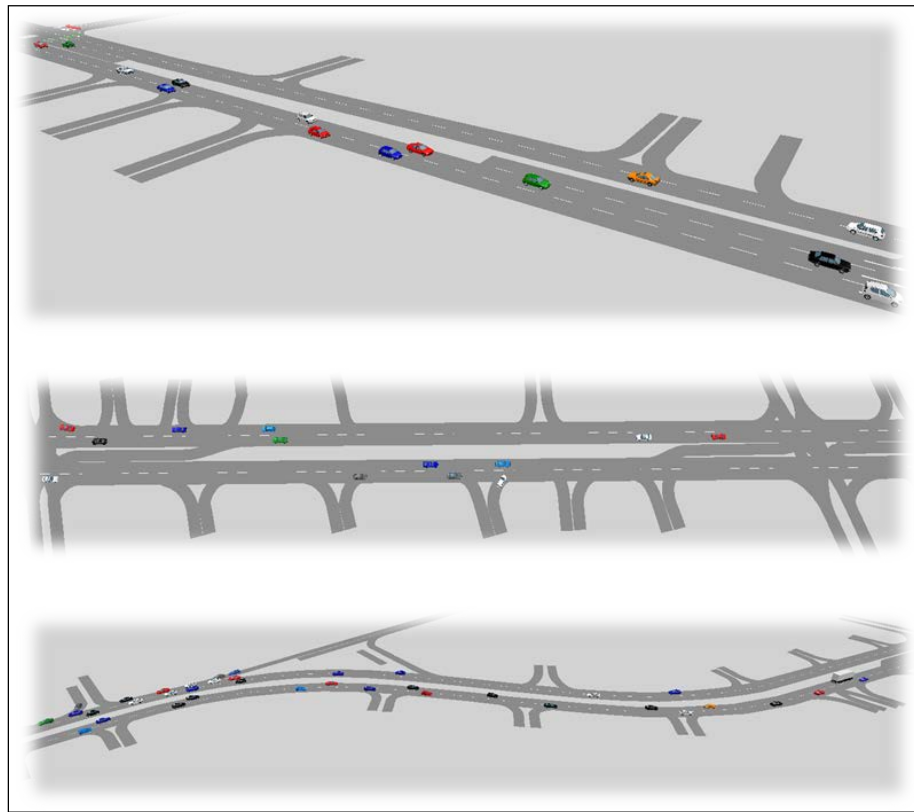
Land Use	Code Name	ITE Code	PM Peak		
			Enter	Exit	Total
Emission Plus	Automobile Care Center	942	4	3	7
Office Complex	General office	710	3	16	19
Timp Valley Floral	Specialty Retail Center	814	8	7	15
KFC	Fast Food with Drive-Through	934	69	63	132
Signs Now (Design - Signs)	Specialty Retail Center	814	16	13	29
Farmers Insurance Co.	General office	710	1	4	5
Jalisco's Market (Supermarket)	Supermarket	850	32	28	60
Alpine Credit Union	General office	710	1	7	8
Murdock&Searle (Dental Office)	Medical Dental	720	1	2	3
IMJ Therapy, INC.	General office	710	1	2	3
Multy office area	General office	710	4	19	23
Multy office area	General office	710	2	9	11
Buhler's Coin-Operated Laundry	Specialty Retail Center	814	11	9	20
Summers Interiors	General office	710	1	2	3
Affiliated First Title Co.	General office	710	3	12	15
EZ Loan Services	General office	710	0	1	1
Duff Shelley Mower & Cycle (Bike Shop)	Sporting Goods	861	19	22	41
Savage Lnk Tattoo & Piercing	Specialty Retail Center	814	6	4	10
Rocky Mountain Class & tint (Auto shop)	Auto Service	942	9	9	18
NAPA Auto Parts	Auto Parts	843	19	19	38
AF Collision Repair	Auto Service	942	14	14	28
Burger King	Fast Food with Drive-Through	934	76	70	146
UtahRUN (Shoes)	Sporting Goods	861	8	8	16
Thai Thai Cuisine(Restaurant)	High-Turnover (Sit-Down) Restaurant	932	53	45	98
Central Bank with Driving Through	Drive-in bank	912	9	12	21
7-11 Gas Station	Gasoline with Convenience Market	945	28	28	55
Fresh Market	Free standing discount	813	146	146	292
Sentinel (Sales And Management)	General office	710	1	3	4
Rick Albrecht	General office	710	1	2	3
State Farm Insurance Agents	General office	710	1	2	3
Hapary(Swim Wear)	Sporting Goods	861	7	7	14
Bella Ella Boutique (Woman Clothing)	Apparel Store	876	8	8	15
Driving School	General office	710	1	3	4
Husband & Wife (Gift Store(Clothing))	Apparel Store	876	5	5	10
Bella Ella Boutique (Woman Clothing)	Apparel Store	876	15	15	29
AF City Hall	Government Office Complex	733	8	18	26
Bank of America	Walk-in Bank	911	133	170	303
Office Building	General office	710	3	17	20
Bank of America (with Drive Through)	Drive-in bank	912	7	10	17
Vision Center	Medical Dental	720	1	2	3
Jack Morris (Home Cleaning Supply)	General office	710	2	10	12
Emporium Salon	Hair Salon	918	1	1	2
Humphries Archery	Specialty Retail Center	814	15	11	26
Lenny's Guns & Ammo Inc.	Specialty Retail Center	814	4	3	7
Christensen's Department Store	Department Store	875	5	7	12
American Fork Alteration	Specialty Retail Center	814	7	6	13
Hair Salon	Hair Salon	918	1	2	3
Post Office	US Post Office	732	37	35	72
R&R Realty LLC	Specialty Retail Center	814	22	18	40
Pawn Shop	Specialty Retail Center	814	6	5	11
Papa Jones Pizza	High-Turnover (Sit-Down) Restaurant	932	26	23	49

**Table 4-1: Trip Generation for Land Use on Main Street in American Fork (Continued)**

Land Use	Code Name	ITE Code	PM Peak		
			Enter	Exit	Total
Towne Cinemas	Movie Theater without Matinee	443	46	29	49
Legacy Auto Sales	Auto Dealer	841	2	3	5
Avenue Bakery	Bread/Donut	939	122	122	244
Reality	Specialty Retail Center	814	7	5	12
Farmers Insurance Co.	Specialty Retail Center	814	4	4	8
Thai Village	High-Turnover (Sit-Down) Restaurant	932	15	13	28
King & McCleary, LLC	Specialty Retail Center	814	6	4	10
Granite (Construction Co.)	General office	710	0	2	2
Durfey Dry Cleaners & Shirt	Specialty Retail Center	814	12	10	22
Chevron	Gasoline with Convenience Market, Carwash	946	16	16	32
Advance Auto Parts	Auto Parts	843	27	26	53
PMR Auto	Auto Dealer	841	2	2	4
Sodalicious	Specialty Retail Center	814	11	9	20
Dr. Jay P. Grant Chiropractic Physician	Medical Dental	720	0	1	1
Sweet Pea Floral (Flower)	Specialty Retail Center	814	3	2	5
Le Rouge Salon	Hair Salon	918	1	2	3
Glass Slipper	Sporting Goods	861	6	7	13
AAMCO Transmissions	Automobile Care Center	942	6	5	11
Alpine Lock & Safe	Specialty Retail Center	814	7	5	12
Relik Salon and Spa	Hair Salon	918	2	2	4
Jewelry Dalley Gifts	Specialty Retail Center	814	4	3	7
Fabric Center	Specialty Retail Center	814	18	15	33
Mexican Market	Supermarket	850	16	14	30
Western Union	General office	710	0	1	1
Salon Signatures	Specialty Retail Center	814	2	2	4
Custom Tailoring	Apparel Store	876	2	2	4
Multy office area	General office	710	6	29	35
Buisness Complex	Specialty Retail Center	814	45	35	80
Humphries INC (Welding Supplies)	Specialty Retail Center	814	19	15	34
Nationwide (Advance Planning Ins.)	General office	710	1	2	3
Tabacco Store, Law Office, Irish Dance	Specialty Retail Center	814	16	13	29
American Fork Senior Citizens Center	General office	710	1	7	8
AF Library	Library	590	58	54	112
Alpine Tabernacle	Church	560	6	6	12
O'Reilly Auto Parts	Auto Parts	843	26	25	50
Greenwood Service (Car Experts)	Automobile Care Center	942	8	7	15
McGee's Stamp & Trophy	Specialty Retail Center	814	7	6	13
Multy office area (Puppy Barn, Gandolfo's New York Deli, Calvary Mountain View Church)	General office	710	5	27	32
Wendy's (Drive Through)	Fast Food with Drive-Through	934	81	74	155
Mi Ranchito	High-Turnover (Sit-Down) Restaurant	932	46	39	85
McDonald's (Drive Through)	Fast Food with Drive-Through	934	126	116	242
Arby's (Drive Through)	Fast Food with Drive-Through	934	72	67	139
Multy Complex (7-Eleven, Rocky Mountain Wingshak, L.A. Nails, Family Storehouse, Cold Stone Creamery, 5th East Hall Bed & Breakfast)	Specialty Retail Center	814	67	52	119
Starbucks	Coffee/Donut Shop with Drive-Through Window	937	81	75	156
Jam Master Car Audio	Auto Parts	843	14	13	27



**Figure 4-1: VISSIM simulation model of the TWLTL median of Main Street**



**Figure 4-2: VISSIM simulation model of the raised median of Main Street**

#### 4.4 Summary

Since the original VISSIM model for the Main Street study section in American Fork provided by UDOT did not have detailed descriptions of the 95 land uses and 77 access driveways along the study section, these driveways were added to the model. Adding driveways in the VISSIM simulation model was essential for comparing safety effects of different median treatments because the patrons of the businesses and other land uses along the study section can freely turn in and out mid-link when a TWLTL median treatment is used and because conflicts due to vehicles from the land uses must be correctly modeled to compare safety effects of the two median treatments. To reflect the traffic conditions on Main Street in the VISSIM model, a traffic demand analysis using the 8th Edition of the ITE Trip Generation Manual was performed. The basic concept of the demand estimation for the study section reflects three of the four steps of the classic four-step urban traffic demand forecasting process. Because traffic volumes and vehicle compositions in traffic volume on Main Street were already set in the original VISSIM model for the study section the mode split step was omitted. In total, for the two median types (TWLTL and raised median), 150 simulation runs were conducted.

## 5 EVALUATION OF SSAM'S CAPABILITIES

The purpose of this chapter is to report the results of the analysis to evaluate whether SSAM can “simulate” safety implications of the University Parkway study section. This is done by comparing the conflict frequency and location estimations obtained by SSAM from the trajectory files of a 75-minute VISSIM simulation model of the study section with five years of actual crash data, from 2010 to 2014.

### 5.1 Results of Analysis

The study site used for the evaluation work was broken into seven segments as shown in Table 5-1 and Figure 5-1. Table 5-1 shows the seven segments with their start and end points, length, and AADT. Segmentation of the study section was done because the AADT varied significantly along the University Parkway study section. The information about the University Parkway study section in Table 5-1 and Figure 5-1 was taken from UDOT's Open Data Portal (UDOT 2016).

**Table 5-1: Specification of Each Segment of the Calibration Study Site (UDOT 2016)**

Segment	Start Point	End Point	Length	AADT
1	0.423	0.725	0.302	47,295
2	0.725	1.713	0.988	46,805
3	1.713	2.276	0.563	51,950
4	2.276	2.727	0.451	40,660
5	2.727	3.647	0.920	30,030
6	3.647	4.118	0.471	34,790
7	4.118	4.336	0.218	38,960



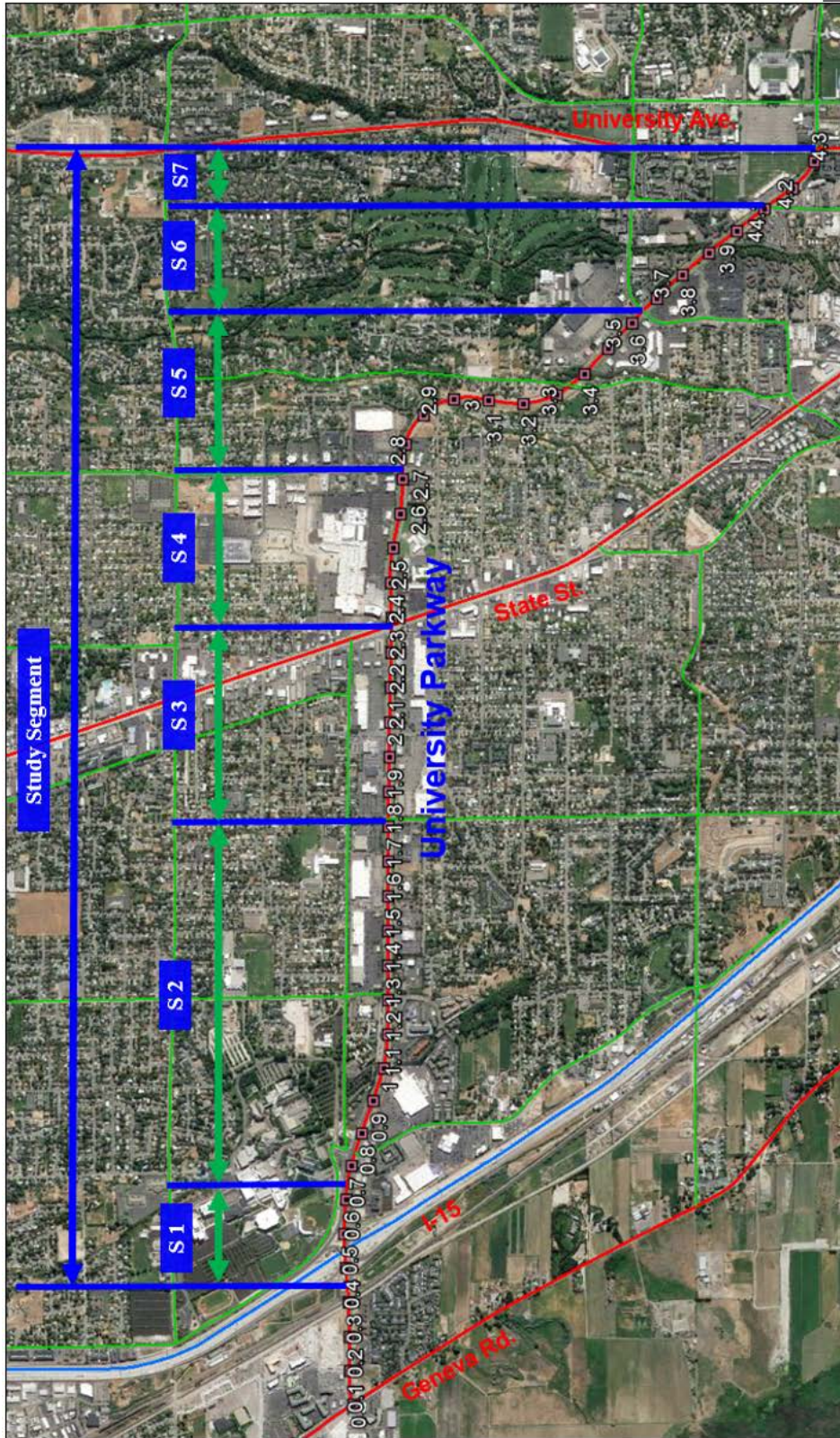


Figure 5-1: University Parkway study site (UDOT 2016)



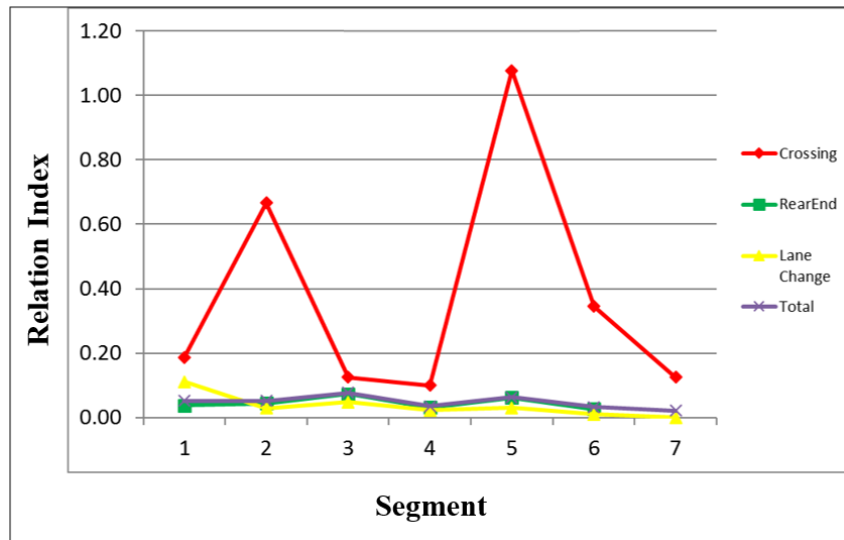
In this evaluation, the average frequencies of conflict points and their locations obtained from the conflict point analysis by SSAM of the trajectory files of 10 runs of the VISSIM model of the study section were compared with the trends of actual crash occurrences, by both frequency and location. Table 5-2 shows the number of actual crashes obtained from the five-year crash records from year 2010 to 2014 and the average number of conflicts obtained from the VISSIM simulation runs for each segment. Because SSAM analyzes three conflict types (crossing, rear-end, and lane-change conflicts), the actual crashes were also grouped into these three categories. To compare the trend in actual crash occurrences and conflict points determined by SSAM, a relation index was calculated, which is the ratio between the number of actual crashes divided by the number of conflicts. This normalization was needed because a direct comparison of the numbers of crashes and the number of potential conflict points could not be made due to the difference in the timeframes of these values. Table 5-3 shows the results of this comparison in a table format and Figure 5-2 shows it in a graphical format. In addition, Figure 5-3 shows the result of spatial analysis comparing the real crash data plotted by ArcGIS and the conflict points obtained from the SSAM spatial analysis for Segment 1 of the study site. It shows a general similarity in the location and concentration of simulated conflicts and actual crashes along the University Parkway study section. Similar figures were created for the other six segments and they can be found in Appendix B of this report. As shown in Figure B-1 through Figure B-6 in Appendix B, all the remaining six segments show a similar general trend between the location and concentration of conflict points and actual crashes.

**Table 5-2: Numbers of Actual Crashes and Conflicts Identified by SSAM**

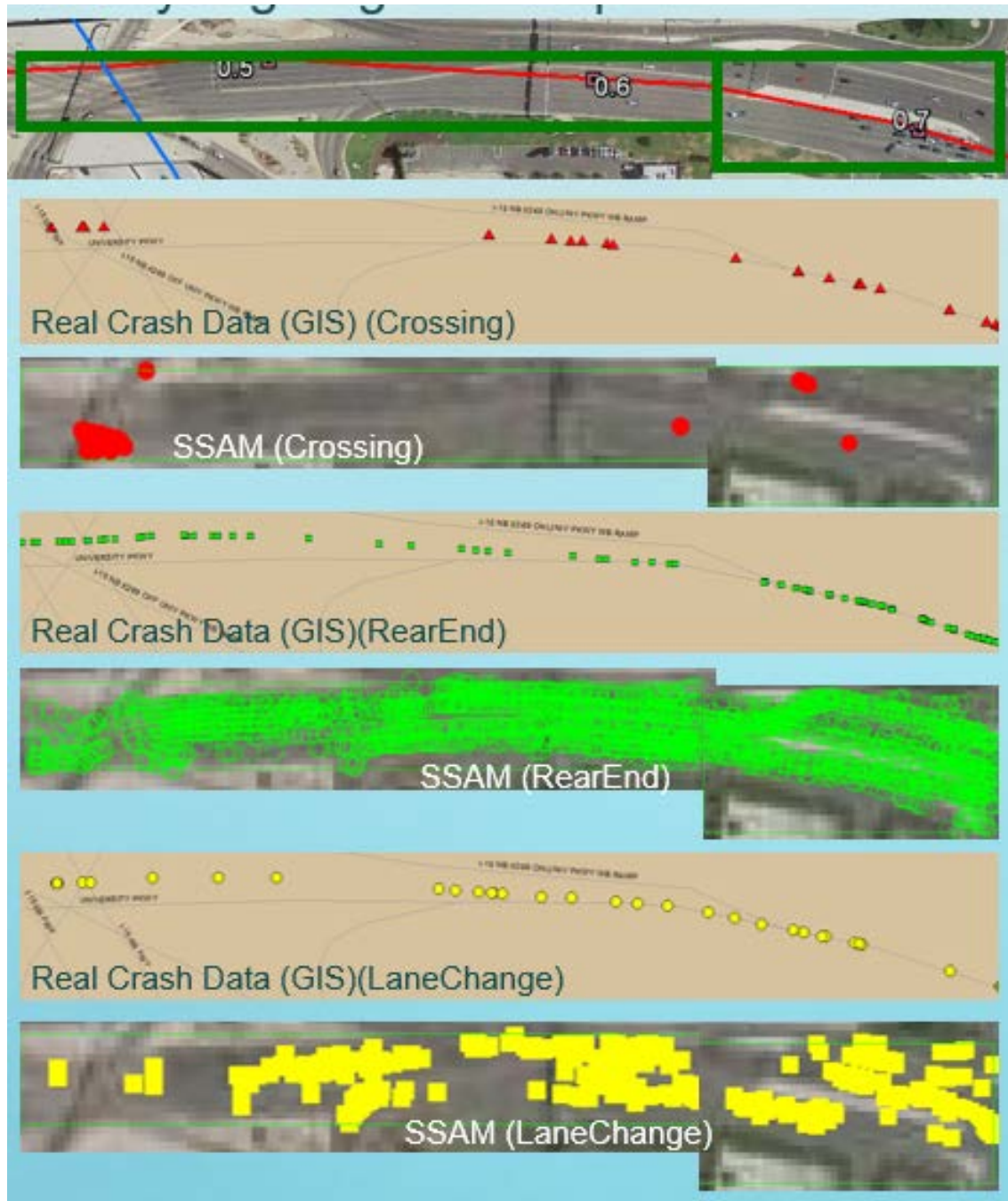
Segment	Number of Crashes (2010 – 2014)				Number Conflicts (75 min)			
	Crossing	Rear End	Lane Change	Total	Crossing	Rear End	Lane Change	Total
1	29	123	43	195	156	3,251	385	3,792
2	84	288	35	407	126	6,471	1,219	7,816
3	91	268	34	393	728	3,622	707	5,057
4	20	67	9	96	200	2,111	399	2,710
5	14	85	10	109	13	1,379	324	1,716
6	10	24	2	36	29	888	187	1,104
7	2	9	0	11	16	411	93	520

**Table 5-3: Relation Indices**

Segment	Relation Index = (Number of Crashes)/(Number of Conflicts)			
	Crossing	Rear End	Lane Change	Total
1	0.1859	0.0378	0.1117	0.0514
2	0.6667	0.0445	0.0287	0.0521
3	0.1250	0.0740	0.0481	0.0777
4	0.1000	0.0317	0.0226	0.0354
5	1.0769	0.0616	0.0309	0.0635
6	0.3448	0.0270	0.0107	0.0326
7	0.1250	0.0219	0.0000	0.0212



**Figure 5-2: Relation indices**



**Figure 5-3: Spatial analysis – Segment 1 of the University Parkway study section**

As shown in Table 5-3 and Figure 5-2, the relation index for total conflicts ranged from 0.0212 to 0.0777. In terms of individual conflict types, the relation indices of rear-end and lane-change crashes and these conflict groups were relatively stable and ranged from 0.0107 to 0.1117

while the crossing crash and conflict comparison group had two relation indices that appeared outliers, ranging from 0.1000 to 1.2500. A confidence interval of the mean at a 95 percent confidence level was obtained to see if the data points that appear outliers were statistically considered as outliers. Table 5-4 shows the results of the 95 percent confidence intervals for each conflict group. As shown in Table 5-4 none of the relation indices fell outside of the 95 percent confidence interval of the mean in each comparison group. Hence, it was concluded that the trend in the occurrence of conflicts determined by SSAM could be used as surrogate values of the actual crash occurrences to test safety impacts of access management alternatives. The four values in the shaded cells are the highest relation index in each conflict group. These four values were all within the 95 percent confidence intervals for different conflict types.

**Table 5-4: Statistical Analysis of Relation Indices**

Segment Number	Crossing	Rear End	Lane Change	Total
1	0.1859	0.0378	<b>0.1117</b>	0.0514
2	0.6667	0.0445	0.0287	0.0521
3	0.1250	<b>0.0740</b>	0.0481	<b>0.0777</b>
4	0.1000	0.0317	0.0226	0.0354
5	<b>1.0769</b>	0.0616	0.0309	0.0635
6	0.3448	0.0270	0.0107	0.0326
7	0.1250	0.0219	0.0000	0.0212
Average	0.375	0.043	0.036	0.048
SD	0.369	0.019	0.037	0.019
DF = n - 1	6	6	6	6
t-critical value for 2-sided 95% confidence	<b>2.447</b>	<b>2.447</b>	<b>2.447</b>	<b>2.447</b>
Lower limit 95% confidence interval	-0.527	-0.004	-0.054	0.000
Upper limit 95% confidence interval	1.277	0.089	0.126	0.095

## 5.2 Summary

The purpose of this task was to calibrate whether SSAM could simulate safety implications of the University Parkway study section by comparing the conflict frequency and location estimations resulting from a 75-minute VISSIM simulation model of the facility and the

actual crash frequency data of five years from year 2010 to 2014 for the study section. To compare the trend in actual crash occurrences and conflict points by SSAM, a relation index was calculated as a ratio between the number of actual crashes divided by the number of conflicts estimated by SSAM. It was found that the relation indices of rear-end and lane-change crash and conflict groups were relatively stable while the relation index of crossing crash and conflict comparison group had two relation indices that appeared outliers. However, a 95 percent confidence interval analysis showed that none of the relation indices fell outside of the 95 percent confidence interval determined by the data from the seven segments of the study site, especially for the crossing crash and conflict comparison group. Hence, it was concluded that the trend in the occurrence of conflicts determined by SSAM could be used as a surrogate for the trend in actual crash occurrences and as a tool for evaluating safety effects of planned access management alternatives. Based on this outcome of the calibration task, the BYU researchers concluded that SSAM could be used to evaluate safety impacts of access management alternatives. For this comparison task, a section of Main Street (US-89) between 300 West and 500 East in American Fork was used and the results of the study are presented in Chapter 6.

## **6 APPLICATION OF SSAM FOR EVALUATING SAFETY EFFECTS OF TWO DIFFERENT MEDIAN TREATMENTS**

The analysis of the University Parkway study section in Chapter 5 showed that SSAM could be used as a surrogate safety analysis tool, therefore, a test site was chosen to evaluate safety impacts of access management alternatives. The access management measures compared in this study were a TWLTL median and a raised median. A section of Main Street (US-89) between 300 West and 500 East in American Fork was selected for this analysis because a VISSIM model for this section was available from UDOT and the section currently has a TWLTL median. The analysis evaluated how much of a safety improvement could be achieved by a raised median at the study section and at what level of traffic volume a raised median could perform better than a TWLTL in terms of potential reduction of crashes. The model was first evaluated to check the similarity of frequency and locations of conflict locations and the frequency and locations of actual crashes to make sure the model reflects actual crash occurrence trends. This chapter presents the results of the two-phase analysis used for the Main Street study section.

### **6.1 Results of the Model Calibration**

Figure 6-1 shows the study section of Main Street (US-89) between 300 West to 500 East in American Fork, approximately 1.2 miles in length. Both sides of the study section have various types of businesses and other land uses. Because of the difference in AADTs, the study

section was divided into two segments. Table 6-1 presents the characteristics of the two segments including the starting mile point, ending mile point, length, number of accesses, access density, and AADT. As shown in Table 6-1 the access densities of the two segments are similar, 62 to 63 accesses/mile, but their AADTs are quite different, which was the main reason to divide the study section into two segments.

**Table 6-1: Characteristics of Each Segment of the Study Section (UDOT 2016)**

Segment	Start Point	End Point	Length (mile)	Number of Accesses	Access Density (Access/mile)	AADT
1	347.971	348.542	0.571	36	63.05	23,780
2	347.360	347.971	0.611	38	62.19	29,870
<b>Section</b>	347.971	347.971	1.182	74	62.61 (Average)	26,825 (Average)

Just as the evaluation work done for the University Parkway study section, the SSAM outputs were calibrated for the Main Street study section with 10 simulation runs. Table 6-2 shows the number of crashes from the crash data and the number of conflicts from SSAM. Both crashes and conflict types were grouped into three groups: crossing, rear-end, and lane-change crashes or conflicts. Total numbers of crashes and conflicts are also shown in the table. The relation index concept used for the University Parkway analysis was also applied to this study section. Table 6-3 presents the relation indices calculated for the two segments. Overall, the variation in relation indices was much smaller than the variation found at the University Parkway study section.

**Table 6-2: Number of Crash Data Record and Conflicts Points**

Segment	Number of Crashes (2010 – 2014)				Number of Conflicts (75 min)			
	Crossing	Rear End	Lane Change	Total	Crossing	Rear End	Lane Change	Total
1	30	49	0	79	84	764	158	1,006
2	73	67	8	148	192	1,880	434	2,506
<b>Section</b>	103	116	8	227	276	2,645	592	3,513



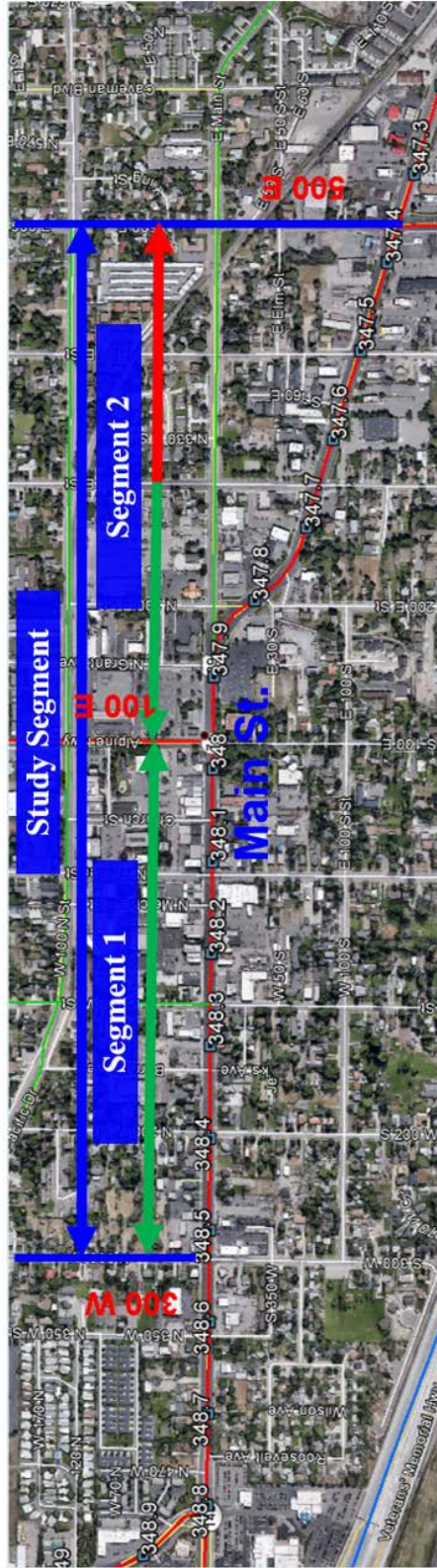


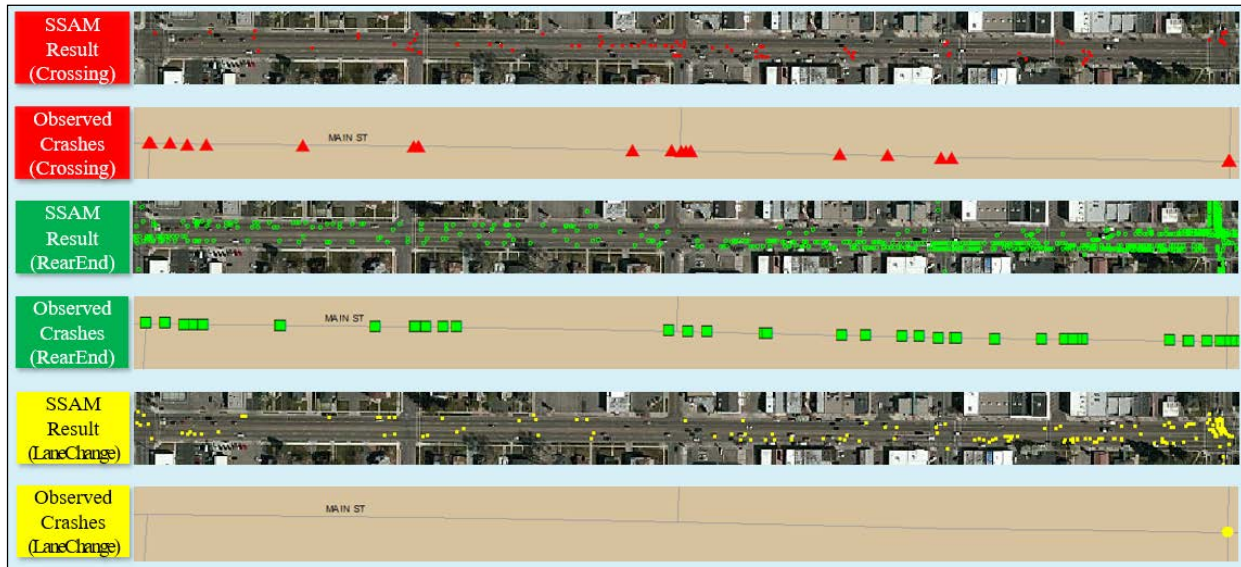
Figure 6-1: Study site (Main Street between 300 West and 500 East in American Fork) (UDOT 2016)



**Table 6-3: Relation Indices of the Two Segments**

Segment	Relation Index = (Number of Crashes)/(Number of Conflicts)			
	Crossing	Rear End	Lane Change	Total
1	0.355	0.064	0.000	0.078
2	0.380	0.036	0.018	0.059
Section	0.373	0.044	0.014	0.065

Figure 6-2 and Figure 6-3 show the spatial distributions of conflict points and actual crashes for Segment 1 and Segment 2 of the Main Street study section, respectively. They are presented in pairs of three different conflict and crash types, namely crossing, rear-end, and lane-change crashes and conflicts. As shown in these figures, general trends in their location and concentration of crashes and conflicts are similar between the conflict points determined by SSAM and the crash locations obtained from the crash data.



**Figure 6-2: Spatial analysis of Segment 1 of the Main Street study section**

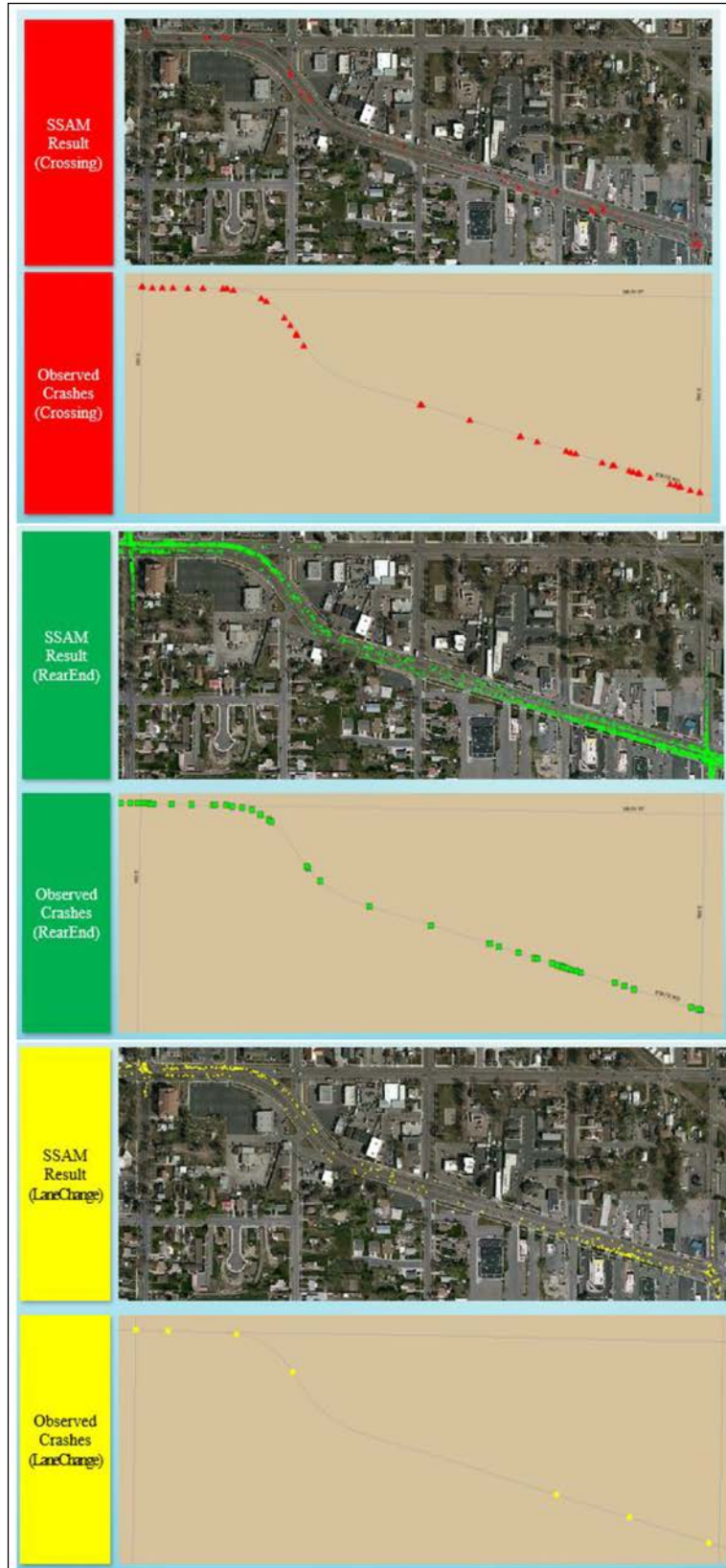


Figure 6-3: Spatial analysis of Segment 2 of the Main Street study section

## 6.2 Use of SSAM to Evaluate Safety Impacts of Access Management Alternatives

Now that the SSAM was calibrated for the Main Street study section, safety impacts of the two types of access management alternatives were compared using this section as an example: a TWLTL median and a raised median. Currently the study section has a TWLTL median. How much safety improvement can be made by installing a raised median? What would be the threshold of AADT to consider a raised median over a TWLTL median? These were two typical questions the traffic engineer would have in mind when considering replacing a TWLTL median with a raised median. This exercise is an example of using SSAM as a tool to evaluate safety impacts of an access management alternative that can be implemented in the future.

To answer these two questions, Main Street volume and volumes from the access driveways along the study section were modified. Using the original traffic volumes that came with the original model as the base, traffic volumes on Main Street and all the access driveways were increased at 10 percent increments up to 40 percent of the base volumes, beyond which the simulation model began encountering problems during the analysis, indicating that the model could not handle more than that volume level. In the end, 25 combinations of volume levels were tested for each median type: base volume, 10 percent increase, 20 percent increase, 30 percent increase, and 40 percent increase on Main Street and access driveway volumes, totaling 25 volume level combinations. For each combination, three VISSIM runs were made to get the mean frequencies of conflicts.

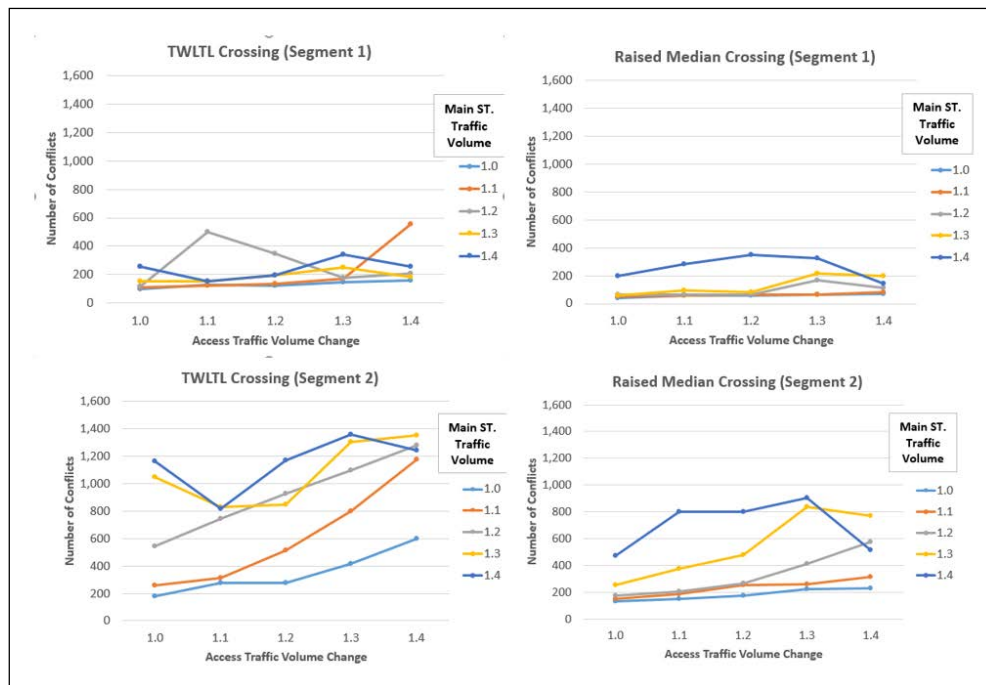
Appendix C contains the number of conflicts that have resulted from these runs. Each table in Appendix C contains six columns. The “Main” column in the table indicates traffic volume levels on Main Street and the subdivisions within the Main Street column indicate the increased rate in traffic volume on access driveways. For instance, 1.0 indicates the base traffic

volume that came with the VISSIM model supplied by UDOT and 1.4 indicates a 40 percent traffic volume increase above the base traffic volume. Each volume combination was run three times and the number of conflict points are shown for each run in Appendix C. The last column on the right of the table in Appendix C shows the average number of conflicts for each volume increase combination.

Figures 6-4 through Figure 6-15 show average number of conflicts for three conflict types for different volume combinations and the total number of conflicts. The figures are given in a set of three. First, results were shown in two-dimensional format followed by a three-dimensional format for each conflict type. Three-dimensional graphs were prepared to allow an intuitive comprehension of the volume combinations at which sudden changes in the number of conflicts might occur. It is difficult to extract such information from two-dimensional figures, which is the reason why three-dimensional figures were prepared. Then, the top views of the three-dimensional figures were prepared, which present the number of conflict points in “contours” of crash frequency levels, thus providing an opportunity to evaluate at what level of volume combinations the number of conflicts would change significantly. The top-view projections of the three-dimensional figures provided a clue for answering the second question posed at the beginning of this chapter.

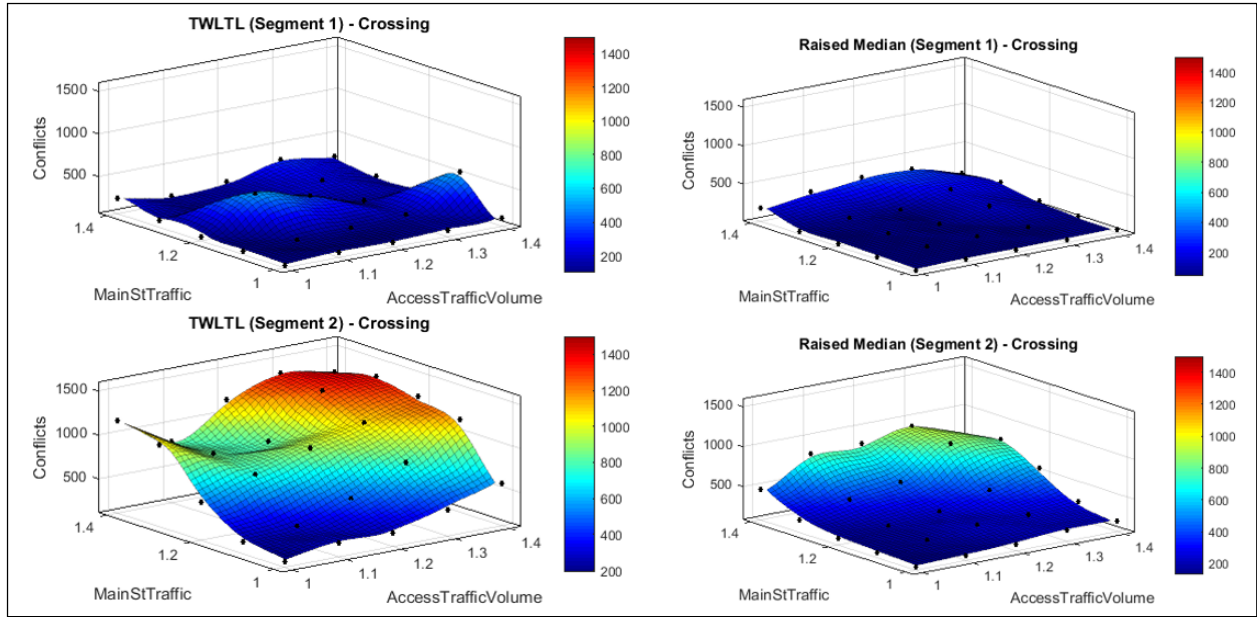
Since severe crashes tend to occur in crossing conflicts, the crossing conflict type is used to discuss general trends manifested in the conflict level contours. As shown in Figure 6-4, the numbers of crossing conflicts are quite similar between the TWLTL and raised medians in Segment 1, while they are significantly different between the two median types in Segment 2. The 2014 AADT of Segment 1 is 23,780 veh/day and AADT of Segment 2 is 29,870 veh/day, as shown in Table 6-1. Therefore, it can be said that at an AADT of approximately 24,000 veh/day

there is not much difference in safety-related benefits of these two access management alternatives even after volume increases. As AADT increases, however, a raised median begins to provide much safer traffic conditions compared to a TWLTL median as demonstrated in Segment 2 of the study site as shown in Figure 6-4 and Figure 6-6. The results found in Segment 2 clearly show how much a raised median can reduce the number of crossing conflicts. For example, the number of crossing conflicts for the TWLTL median through Segment 2, with a 40 percent volume increase on Main Street, ranges from 800 to 1,400, whereas the number of crossing conflicts for the raised median, with the same 40 percent volume increase on Main Street ranges from 400 to 900, a 50 percent to 32 percent reduction in crossing conflicts in Segment 2. Although the range of the number of conflicts for each conflict type differs among other conflict types, a similar trend can be observed for rear-end and lane-change conflicts as shown in the top-view projections shown in Figure 6-9 and Figure 6-12. A similar trend can also be seen in the top-view projection of the total number of conflict points as shown in Figure 6-15.

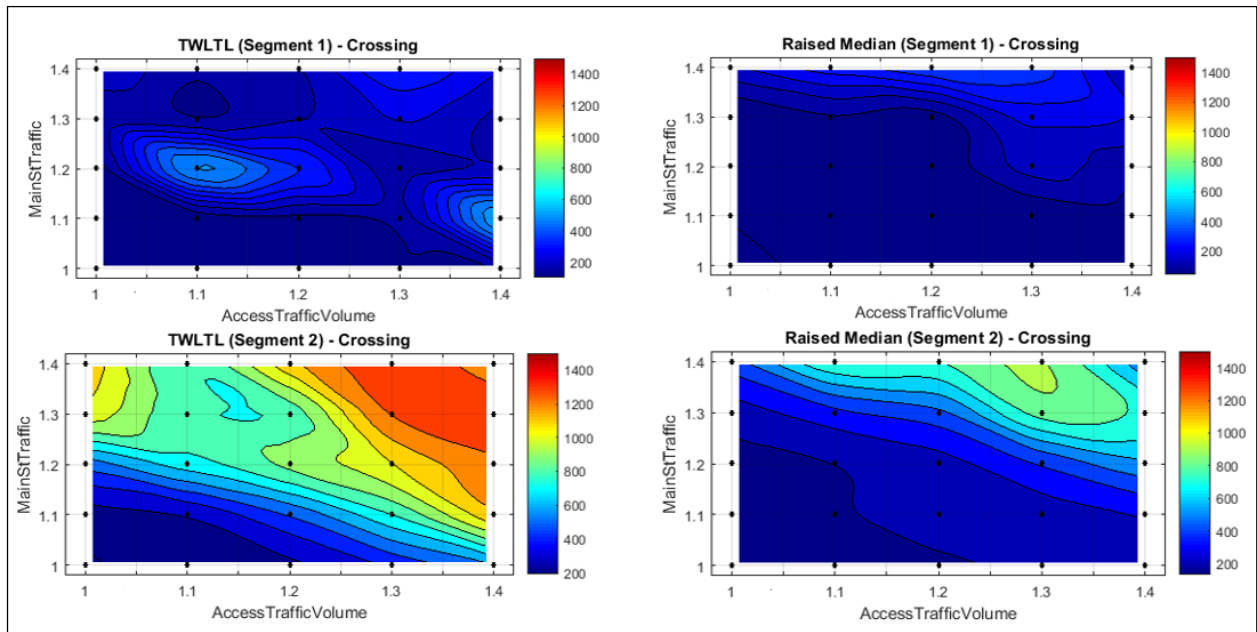


**Figure 6-4: Comparison of TWLTL and raised median for crossing conflicts**





**Figure 6-5: Three dimensional presentation of changes in the number of crossing conflicts**



**Figure 6-6: Top view of Figure 6-5 for crossing conflicts**

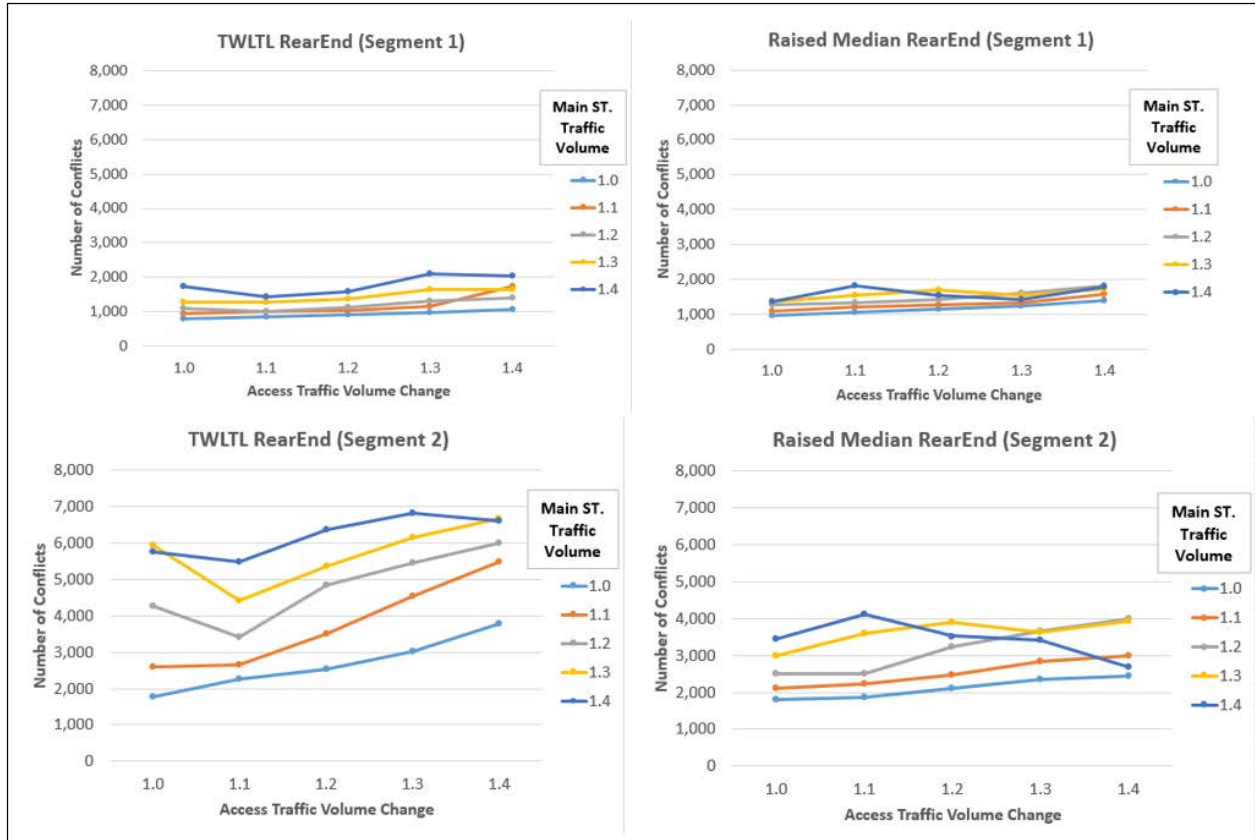


Figure 6-7: Comparison of TWLTL and raise median for rear-end conflicts

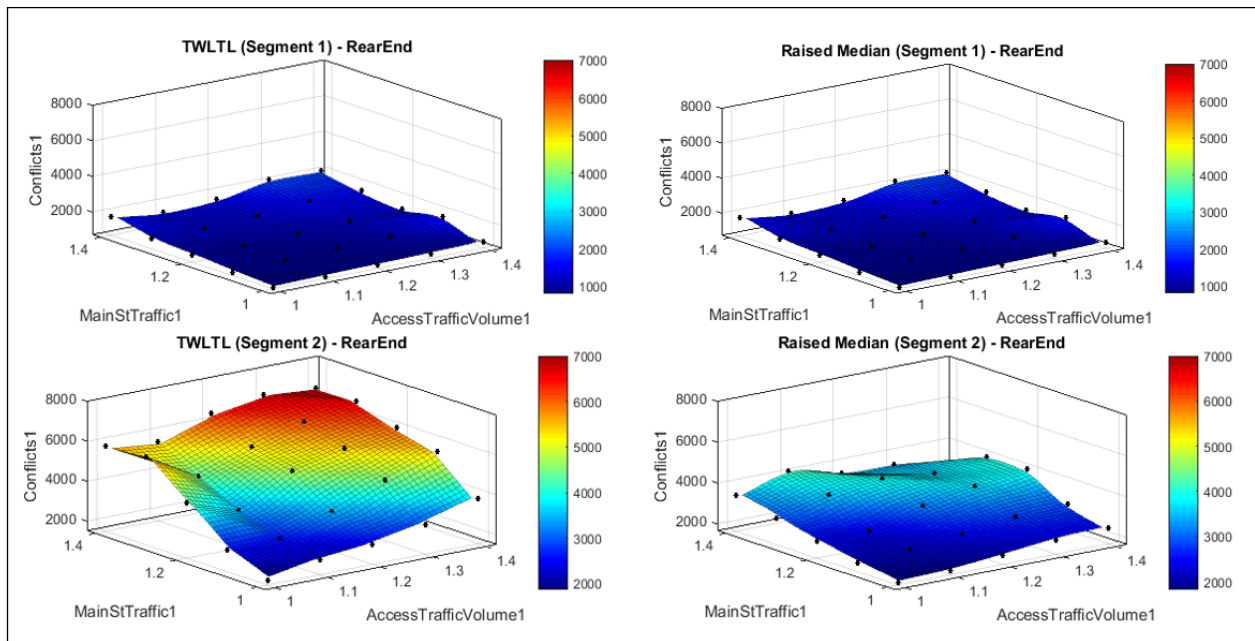


Figure 6-8: Three dimensional presentation of changes in the number of rear-end conflicts

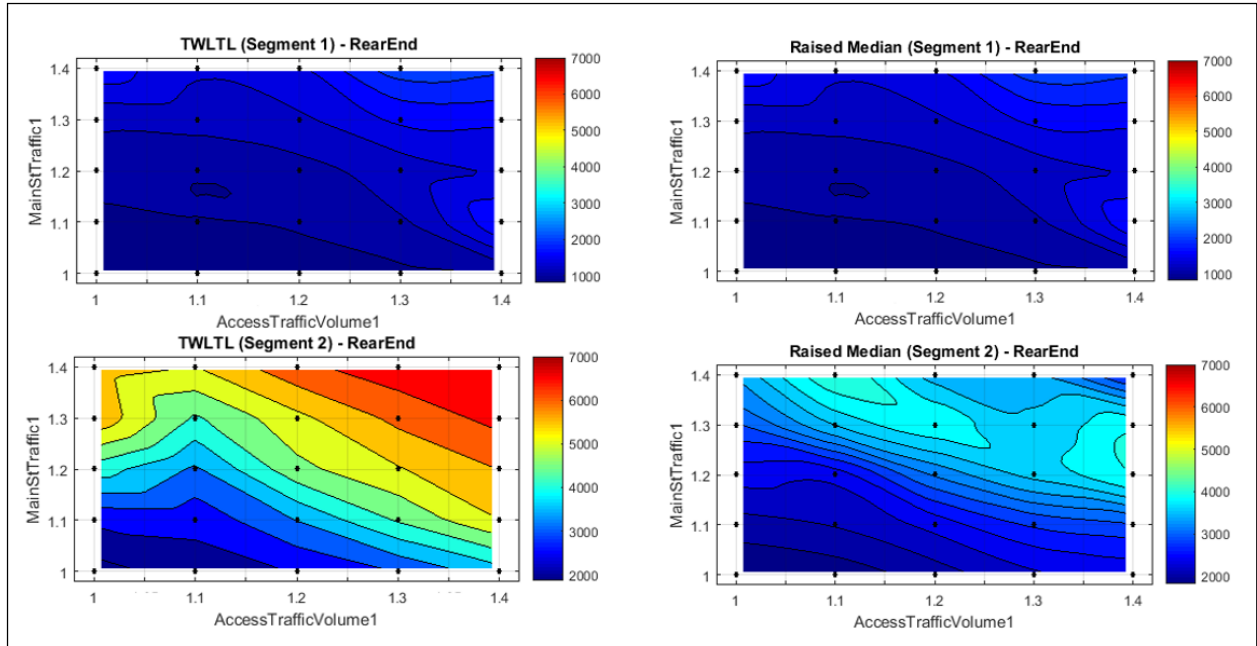


Figure 6-9: Top view of Figure 6-8 for rear-end conflicts

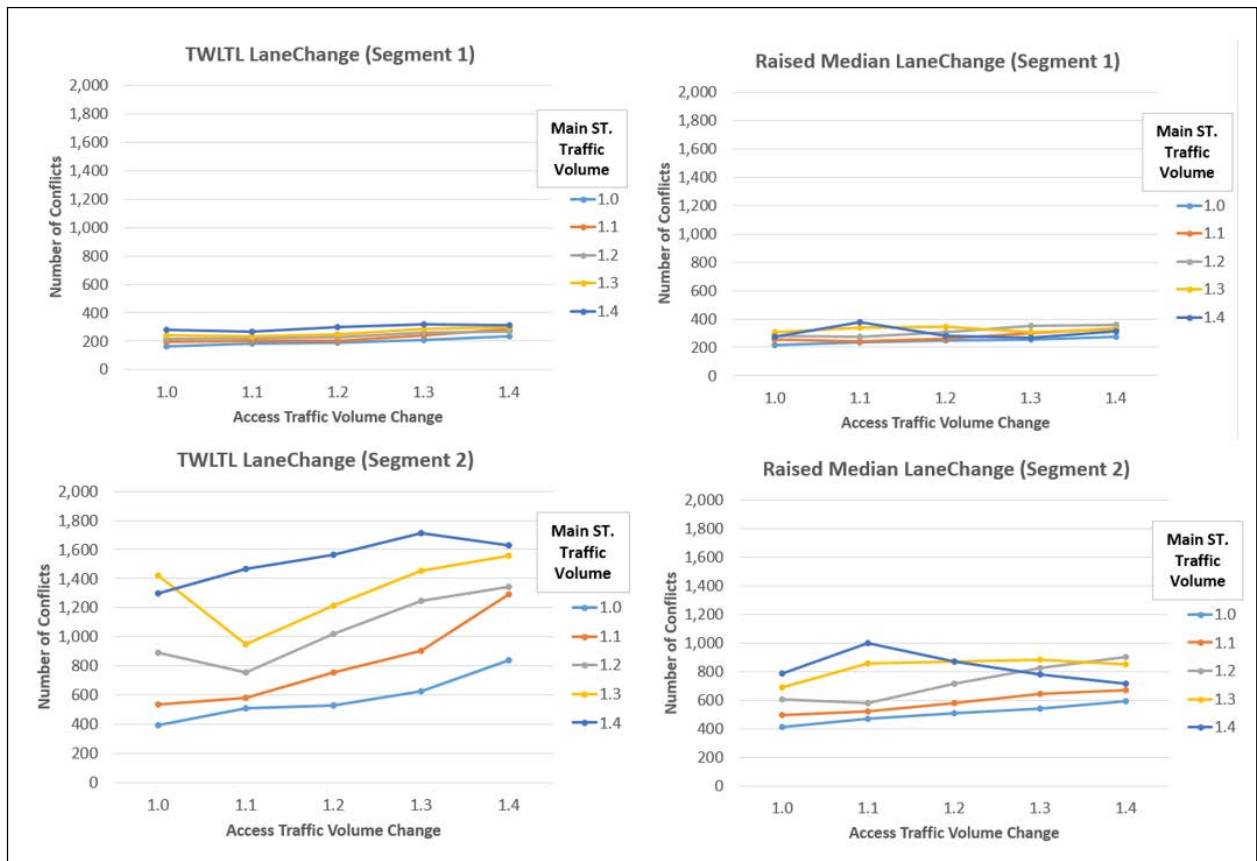


Figure 6-10: Comparison of TWLTL and raise median for lane-change conflicts



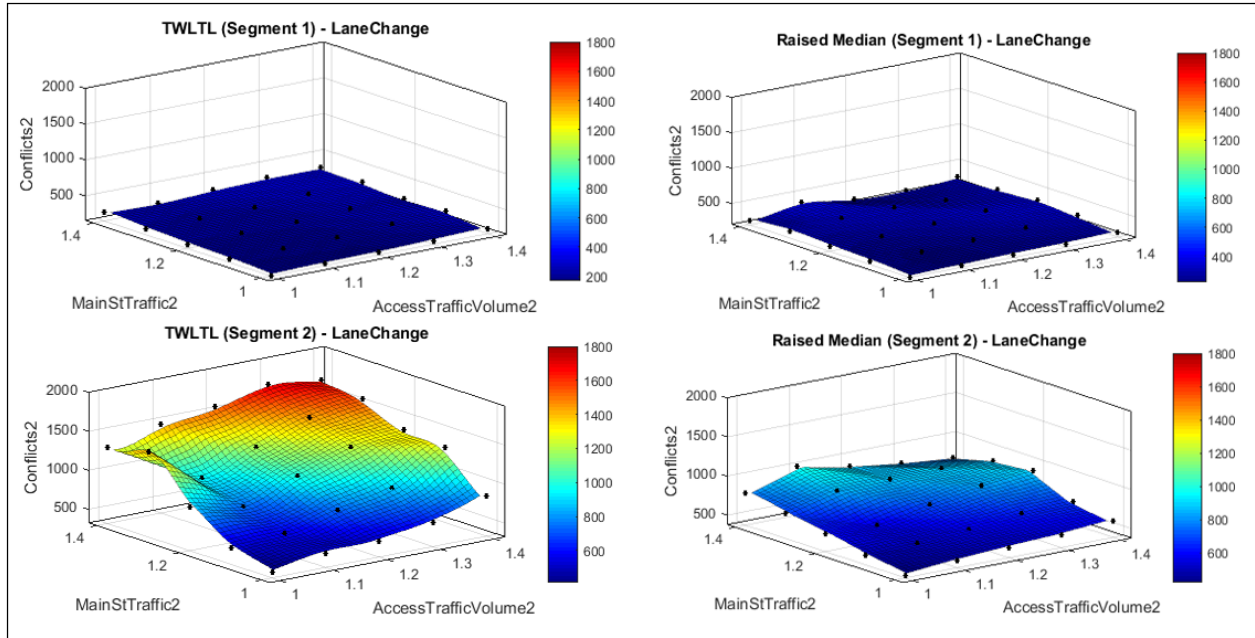


Figure 6-11: Three dimensional presentation of changes in the number of lane-change conflicts

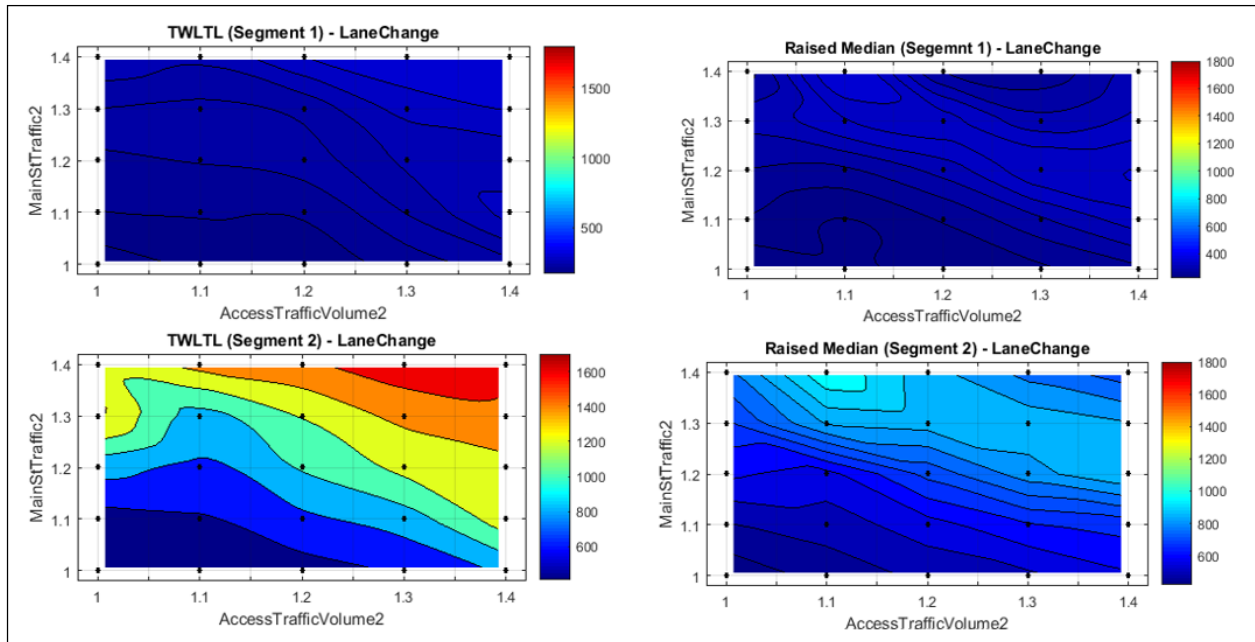


Figure 6-12: Top view of Figure 6-11 for lane-change conflicts

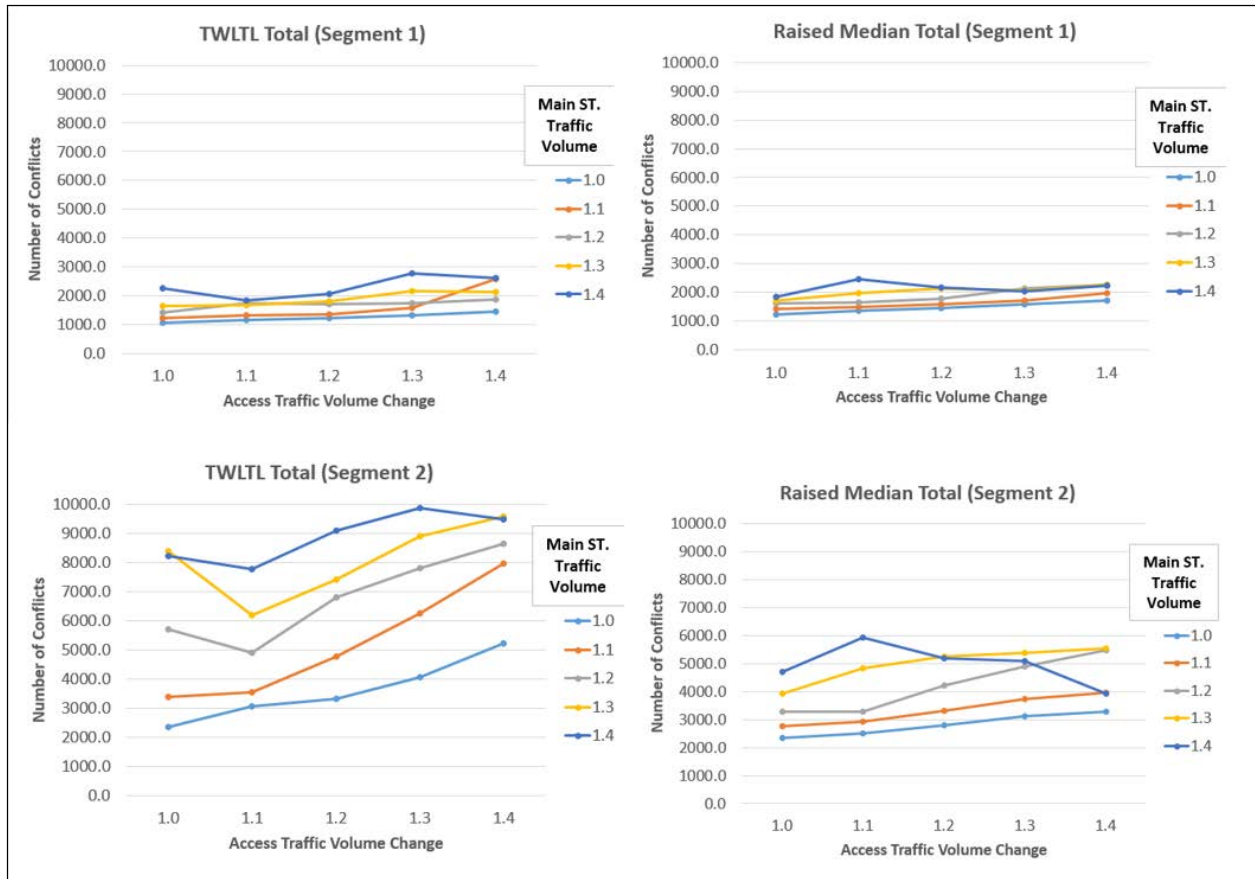


Figure 6-13: Comparison of TWLTL and raise median for total number of conflicts

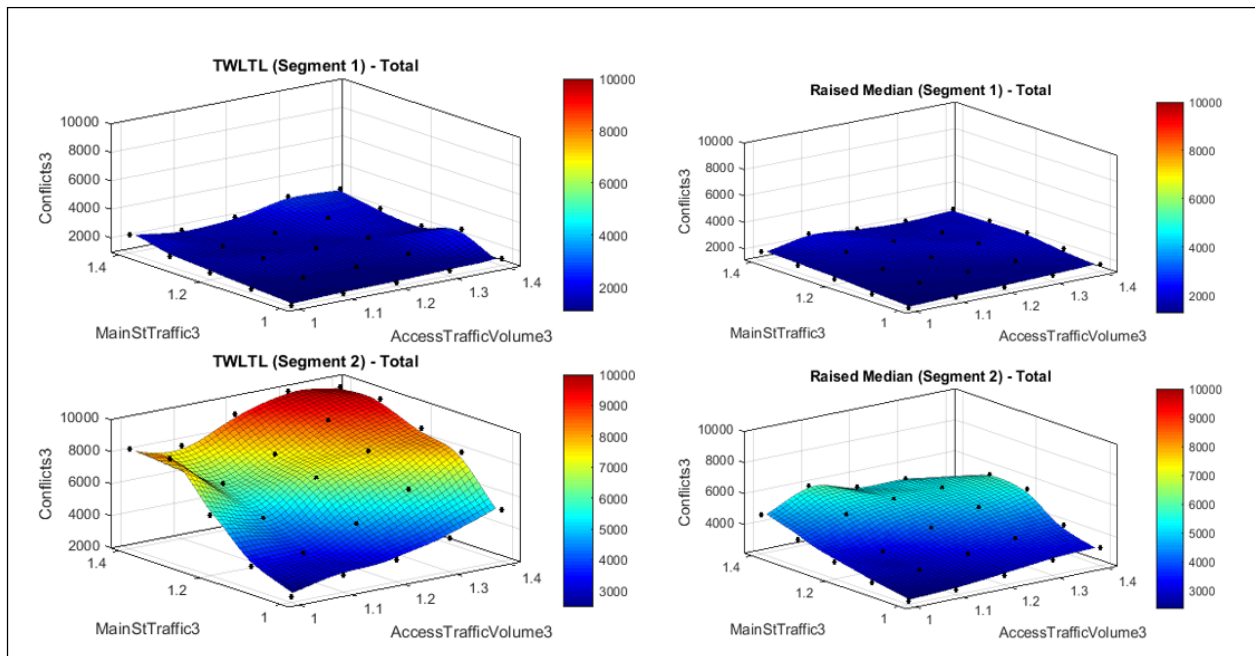
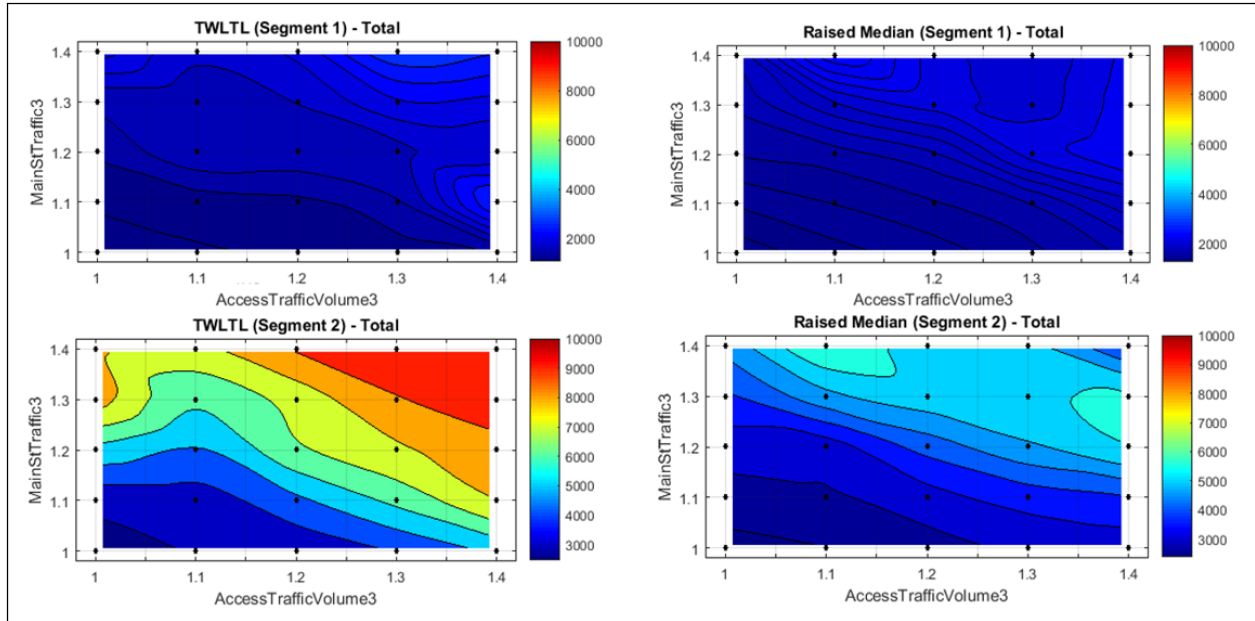


Figure 6-14: Three dimensional presentation of changes in total number of conflicts



**Figure 6-15: Top view of Figure 6-14 for total number of conflicts**

### 6.3 Results of the Sensitivity Analysis

Tables 6-4 through 6-6 show a brief summary of an Analysis of Variance (ANOVA) for Segment 1 and Segment 2. The ANOVA analysis showed that median type was the most dominant factor that would affect the number of conflicts followed by the volume on Main Street, and then the volume on access driveways. There were some interactions between median type and Main Street volume as shown in these tables; however, overall, median type was the main factor to cause the majority of differences in the number of conflicts between a TWLTL median and a raised median. It was found that there was not much difference in the number of conflict points in the three conflict types in Segment 1, which had an AADT of 23,780 veh/day. In Segment 2, the differences in the number of conflicts were significant as shown in the top-view presentations of the changes in the number of conflicts in Figure 6-6. Segment 2 had an AADT of 29,870 veh/day. Note that both segments have similar access densities, 62 access points per mile in Segment 1 and 63 access points per mile for Segment 2. It is evident that the

median-type affects most significantly the difference in the number of conflicts, followed by Main Street traffic volume and access-driveway traffic volume in this order.

Segment 2 presents clearly the benefit of using a raised median as seen previously in the top views of conflict contours in Figures 6-6, 6-9, 6-12, and 6-15. In order to determine the threshold traffic volume for replacing a TWLTL with a raised median, cyan-colored contours were used as the upper threshold for using a TWLTL and the lower threshold to justify a raised median. This cyan-colored contour was used as a potential threshold value because this color contour does not appear in Segment 1 after a raised median is installed, meaning both access management alternatives have a similar performance in Segment 1 with an AADT of approximately 24,000 veh/day. Since the most critical conflict type is crossing conflicts, it was decided to use the crossing conflict to find the threshold AADT to discuss the benefit of installing a raised median. In the top view contours in Figure 6-6 for crossing conflicts, the cyan-colored contour represents the number of crossing conflicts of about 600. Hence, the number of vehicles per lane for Main Street and its access demand combinations that are on or near the cyan-colored contour were computed.

Figure 6-16 and Figure 6-17 show the results of this threshold traffic volume analysis for TWLTL and raised medians. With the threshold of crossing conflicts in Segment 2 being set to approximately 600, traffic volumes on or near the cyan-colored contour were determined and they were found to be approximately 780 to 864 vehicles per hour per lane. With the raised median, traffic volumes on or near the cyan-colored contour were determined to be 948 to 995 vehicles per hour per lane. The raised median can accommodate 84 to 215 vehicles per hour per lane more to reach the same level of crossing conflicts for the TWLTL median.

**Table 6-4: ANOVA Test Results (Crossing Conflicts)**

<b>a. Full model of segment 1</b>				
Effect	Num DF	Den Df	F Value	Pr>F
Median_Type	1	116	11.76	0.0008
Main Street Traffic Volume	4	116	3.92	0.0051
Access Driveway Traffic Volume	4	116	1.36	0.2538
Median_Type & Main Street Traffic Volume	4	116	1.83	0.1278
Median_Type & Access Driveway Traffic Volume	4	116	0.47	0.7572
Main Street & Access Driveway Traffic Volume	16	116	0.93	0.5348
<b>b. Reduced model of segment 1</b>				
Effect	Num DF	Den Df	F Value	Pr>F
Median_Type	1	140	11.75	0.0008
Main Street Traffic Volume	4	140	3.91	0.0048
Access Driveway Traffic Volume	4	140	1.35	0.2530
<b>c. Full model of segment 2</b>				
Effect	Num DF	Den Df	F Value	Pr>F
Median_Type	1	116	209.12	<0.0001
Main Street Traffic Volume	4	116	67.90	<0.0001
Access Driveway Traffic Volume	4	116	25.94	<0.0001
Median_Type & Main Street Traffic Volume	4	116	6.30	0.0001
Median_Type & Access Driveway Traffic Volume	4	116	5.08	0.0008
Main Street & Access Driveway Traffic Volume	16	116	1.99	0.0190
<b>d. Reduced model of segment 2</b>				
Effect	Num DF	Den Df	F Value	Pr>F
Median_Type	1	140	151.38	<0.0001
Main Street Traffic Volume	4	140	49.15	<0.0001
Access Driveway Traffic Volume	4	140	18.78	<0.0001

**Table 6-5: ANOVA Test Results (Rear-End Conflicts)**

<b>a. Full model of segment 1</b>				
Effect	Num DF	Den Df	F Value	Pr>F
Median_Type	1	116	10.32	0.0017
Main Street Traffic Volume	4	116	35.73	<0.0001
Access Driveway Traffic Volume	4	116	16.78	<0.0001
Median_Type & Main Street Traffic Volume	4	116	5.22	0.0007
Median_Type & Access Driveway Traffic Volume	4	116	1.94	0.1086
Main Street & Access Driveway Traffic Volume	16	116	0.51	0.9374
<b>b. Reduced model of segment 1</b>				
Effect	Num DF	Den Df	F Value	Pr>F
Median_Type	1	140	9.45	0.0025
Main Street Traffic Volume	4	140	32.73	<0.0001
Access Driveway Traffic Volume	4	140	15.38	<0.0001
<b>c. Full model of segment 2</b>				
Effect	Num DF	Den Df	F Value	Pr>F
Median_Type	1	116	414.28	<0.0001
Main Street Traffic Volume	4	116	127.77	<0.0001
Access Driveway Traffic Volume	4	116	33.73	<0.0001
Median_Type & Main Street Traffic Volume	4	116	21.36	<0.0001
Median_Type & Access Driveway Traffic Volume	4	116	12.55	<0.0001
Main Street & Access Driveway Traffic Volume	16	116	3.08	0.0002
<b>d. Reduced model of segment 2</b>				
Effect	Num DF	Den Df	F Value	Pr>F
Median_Type	1	132	330.97	<0.0001
Main Street Traffic Volume	4	132	102.08	<0.0001
Access Driveway Traffic Volume	4	132	26.94	<0.0001

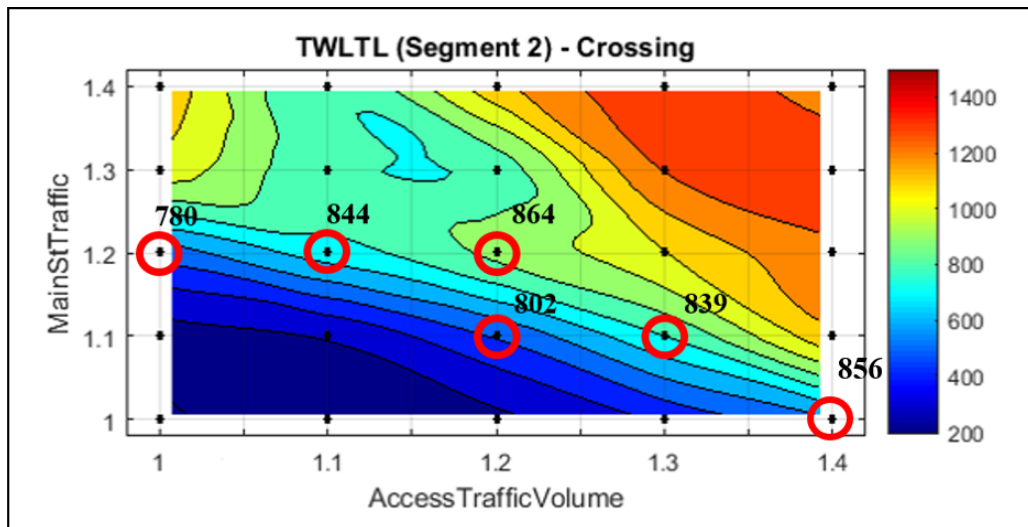
**Table 6-6: ANOVA Test Results (Lane-Change Conflicts)**

<b>a. Full model of segment 1</b>				
Effect	Num DF	Den Df	F Value	Pr>F
Median_Type	1	116	70.94	<0.0001
Main Street Traffic Volume	4	116	23.85	<0.0001
Access Driveway Traffic Volume	4	116	11.47	<0.0001
Median_Type & Main Street Traffic Volume	4	116	4.04	0.0042
Median_Type & Access Driveway Traffic Volume	4	116	1.34	0.2603
Main Street & Access Driveway Traffic Volume	16	116	1.21	0.2673
<b>b. Reduced model of segment 1</b>				
Effect	Num DF	Den Df	F Value	Pr>F
Median_Type	1	140	63.29	<0.0001
Main Street Traffic Volume	4	140	21.27	<0.0001
Access Driveway Traffic Volume	4	140	10.23	<0.0001
<b>c. Full model of segment 2</b>				
Effect	Num DF	Den Df	F Value	Pr>F
Median_Type	1	116	224.91	<0.0001
Main Street Traffic Volume	4	116	93.40	<0.0001
Access Driveway Traffic Volume	4	116	20.56	<0.0001
Median_Type & Main Street Traffic Volume	4	116	19.57	<0.0001
Median_Type & Access Driveway Traffic Volume	4	116	8.66	<0.0001
Main Street & Access Driveway Traffic Volume	16	116	2.06	0.0149
<b>d. Reduced model of segment 2</b>				
Effect	Num DF	Den Df	F Value	Pr>F
Median_Type	1	136	166.66	<0.0001
Main Street Traffic Volume	4	136	69.21	<0.0001
Access Driveway Traffic Volume	4	136	15.23	<0.0001

Knowing that the study segments have four lanes (a total of the number of lanes in both directions), the threshold traffic volume to convert a TWLTL median to a raised median would be approximately 3,120 to 3,460 vehicles per hour ( $780 \times 4 = 3,120$  and  $864 \times 4 = 3,456$  as shown in Figure 6-16). Since the percentage of the current PM peak hourly volume against AADT for the Main Street in the study area is about 9 percent (this percentage was estimated using the traffic volume used in the VISSIM model provided by UDOT and AADT data available from UDOT for year 2014), the threshold AADT for considering the conversion of a

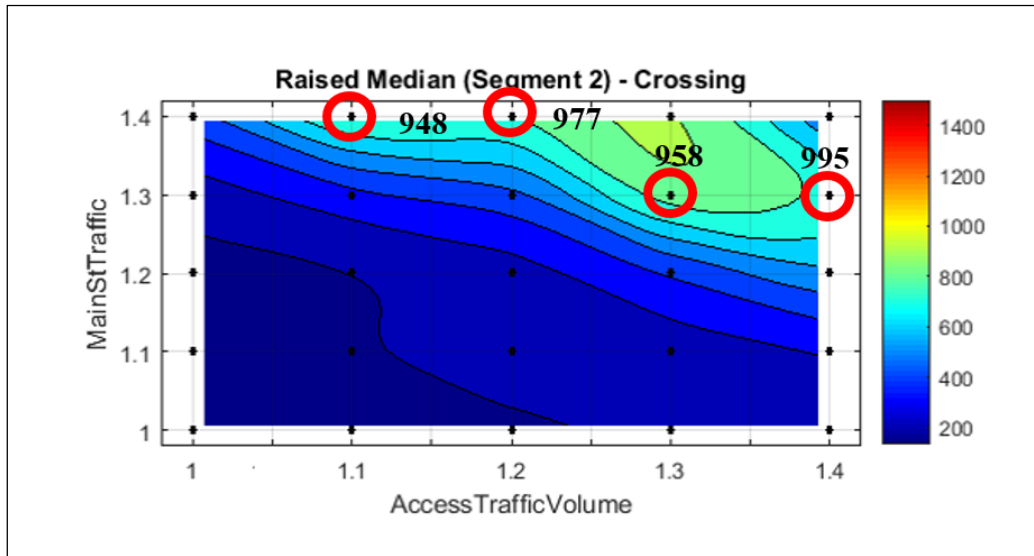


TWLTL median to a raised median would be approximately 34,700 to 38,400 veh/day for the four lanes in Segment 2 (two lanes in each direction). A raised median may begin to have a similar level of crossing conflicts as the one for TWLTL when the hourly volume becomes approximately 3,790 to 3,980 vehicles per hour ( $948 \times 4 = 3,792$  and  $995 \times 4 = 3,980$  as shown in Figure 6-17). With these hourly values, the AADT where a raised median might begin to have an increase in the number of crossing conflicts similar to the TWLTL median would be approximately 42,100 to 44,200 veh/day for the four lanes on Segment 2 of this study section. Similar analyses were done for rear-end, lane-change and total conflicts and their results are included in Appendix D. The threshold AADT values for considering the conversion of a TWLTL median to a raised median determined by these analyses resulted in the AADT values similar to the ones determined for crossing conflicts.



**Figure 6-16: Threshold volume analysis results for TWLTL for crossing conflicts**





**Figure 6-17: Threshold volume analysis results for raised median for crossing conflicts**

#### 6.4 Summary

The evaluation study performed on a segment of University Parkway showed that SSAM could be used to evaluate safety impacts using surrogate measures, that is, potential conflicts, therefore, an evaluation of the effect of converting a TWLTL median into a raised median on a section of Main Street (US-89) between 300 West and 500 East in American Fork was performed using SSAM working on VISSIM simulation's trajectory files. This evaluation study was conducted to show how SSAM could be used to evaluate the safety effects of access management alternatives. Specifically, it was done to answer the following two questions: How much safety improvement can be made by installing a raised median? and What would be the threshold of AADT to consider a raised median over a TWLTL median? The analysis showed that SSAM could provide data for answering these questions. Figures 6-6, 6-9, 6-12, and 6-15 (top view figures of crossing conflicts, rear-end conflicts, lane-change conflicts, and total conflicts) show that a raised median will be much safer than a TWLTL median for the same level of traffic volume. There are much more blue or dark blue contours seen in the top view of

conflict map for the raised median than for the TWLTL median in all conflict types. Also, by assuming a certain level of conflict occurrence level as a potential threshold to convert from a TWLTL median to a raised median (in this study, the threshold level was set to 600 crossing conflicts) and the PM peak hourly volume percentage of 9 percent, average threshold daily traffic volumes in the study section were estimated. It was determined that AADT of about 34,000 to 38,000 veh/day would be the demand level where a TWLTL median could be converted into a raised median for a four-lane section. Also found was that the performance of a raised median might begin deteriorating once AADT becomes approximately 42,000 to 44,000 veh/day for the four-lane section analyzed in this study.

As for safety improvement after replacing a TWLTL median with a raised median, approximately a 32 to 50 percent reduction in the number of crossing conflicts would be achieved when a raised median was used in lieu of a TWLTL median when traffic volumes were increased by 40 percent of the base model at the Main Street study section. The percent reduction in crossing conflicts caused by changing a TWLTL median with a raised median resembles the result of a study that was conducted by Schultz's et al. (2017) in parallel to this study. The study compared crash occurrences before and after a change in median treatment from a TWLTL median to a raised median at 20 study sites statewide, using Bayesian statistics. The study concluded that the median type change achieved crash reduction ranging from 32 to 44 percent for all severity groups except severity 4 and 5, for which a larger reduction of 57 to 58 percent, was achieved.

## 7 CONCLUSION

Safety effects of access management alternatives can be analyzed using before and after studies. However, in a traditional safety impact analysis it is necessary to install an access management alternative in the field and a few years must pass to collect reliable and adequate numbers of crash data. This is a time-consuming process and there remains uncertainty in the crash data due to the random nature of crash occurrences. Another method that has been used is a conflict analysis done in the field. This analysis is not affected by the randomness in crash occurrence but the access management alternative under study must be installed to conduct the analysis and the analyst must wait for several months before conducting a conflict analysis. Because of these data collection issues, a conflict analysis of a proposed access management alternative at a certain site is often done at a segment of a highway that has similar characteristics to the one where the planned access management alternative would be placed.

In summary, the traditional safety-related before-and-after analysis based on crash data is time consuming and costly and it cannot avoid the uncertainty attributed to random occurrence of crashes often attributed to driver errors. On the other hand, the traditional conflict analysis in the field may become time consuming and costly if the same segment where a new access management alternative is planned must be analyzed. If a location with similar traffic characteristics and a similar physical layout is studied to evaluate the effect of the new access management alternative under study for a highway segment, it is not an ideal comparison

because there are no two highway segments with the exact same traffic and physical characteristics. Hence, there has been a need for a safety analysis method that will overcome these issues.

SSAM was developed for the purpose of resolving the problems described in the previous paragraphs. With SSAM, a conflict analysis is done in a simulated environment; thus, the physical and traffic characteristics can be maintained for before and after analyses. A planned access management alternative under study is modeled and no physical installation of the alternative is needed; thus, it is not costly. It is based on a conflict analysis; hence, it is not affected by randomness and uncertainty inherent to crash data. It is also not time consuming like other traditional safety analysis methods that may require a physical installation of a new access management alternative and a waiting time before collecting after data.

The goal of this study was to evaluate if SSAM, a free software program based on a conflict analysis concept, developed by the FHWA could be used to assess the safety effect of an access management alternative and to compare the safety effects of multiple access management alternatives with less time, less cost, and less uncertainty. To meet the goal of the study four objectives were set up for the study: 1) literature review on studies related to SSAM, 2) identification of study locations for which UDOT has already created a simulation model using VISSIM, 3) evaluation of spatial and frequency relationships of conflicts identified by SSAM and actual crash data, and 4) demonstration of potential use of SSAM for evaluating safety impacts of selected access management alternatives using the same physical conditions of study sites for its before and after studies.

In conclusion, the calibration and sensitivity studies conducted in this study showed that SSAM combined with a simulation model could be a viable tool to evaluate the safety effects of

access management alternatives planned for future implementation. In this chapter, a brief summary of the findings from these four tasks are presented and a set of recommendations is offered for future research.

## **7.1 Summary of Literature Review**

The literature review of this study focused on two methods that use surrogate safety measures: TCT and SSAM. Although TCT is free from the reliability issues of using actual crash records and requires much less time for accumulating necessary data for analysis, it still requires existing facilities that have sufficient traffic volume to produce a large enough number of conflicts for meaningful analyses. On the other hand, SSAM is a technique combining microsimulation and an automated conflict analysis, which analyzes the frequency and character of narrowly averted vehicle-to-vehicle collisions in traffic. SSAM allows the user to assess the safety of traffic facilities without actually installing improvement alternatives and waiting for a long time to accumulate a necessary amount of data for analysis. Therefore, analysis time is dramatically reduced. Since SSAM was provided by FHWA in 2003, many validation and application studies have been performed. Although some studies have indicated that some overestimated number of conflicts were observed in the process, this literature review concluded that the methodology using a simulation model and SSAM could be a viable tool to evaluate and compare safety effects of planned highway and intersection improvements.

## **7.2 Findings from the Evaluation of the Capability of SSAM**

The calibration of SSAM using a section of University Parkway in Orem and Provo was performed by comparing the general trends in the frequency and concentration of crossing, rear-end, change-lane, and total number of conflict types and the frequency and concentration of

actual crashes observed in a 5-year period since year 2010 to 2014. It showed that there were similarities between the estimation of conflicts provided by SSAM and the number of actual crashes. Since the timeframes of these data groups were completely different, an index called a relation index was defined and used to test their general similarities. A confidence interval analysis showed that relation indices were statistically stable among the seven segments in the calibration study section of the University Parkway study section. The evaluation work showed that the SSAM analysis using VISSIM model's trajectory files is a viable tool to evaluate the effect of access management alternatives.

### **7.3 Findings from a Sample Analysis of Safety Impacts of Two Access Management Alternatives using SSAM**

Based on the findings from the calibration of SSAM on the University Parkway study section, an evaluation of the effect of converting a TWLTL median into a raised median on a section of Main Street (US-89) from 300 West to 500 East in American Fork was performed in SSAM using the VISSIM simulation trajectory files of the study segment. This evaluation study was conducted to show how SSAM could be used to evaluate the effect of access management alternatives using surrogate safety measures. Specifically, this evaluation was done to answer the following two typical questions that may come to the mind of a traffic engineer: How much safety improvement can be made by installing a raised median replacing a TWLTL? and What would be the threshold of AADT to consider a raised median over a TWLTL? This analysis showed that SSAM could be used as a tool for answering these questions.

The analysis showed that a raised median would be much safer than a TWLTL for the same level of traffic volume. Approximately a 32 to 50 percent reduction in the number of

crossing conflicts would be achieved when a raised median was used in lieu of a TWLTL median on the Main Street study section. This is the answer to engineer's first question mentioned in the paragraph above.

By assuming a certain level of conflict occurrence as a potential threshold to convert from a TWLTL median to a raised median and the PM peak hourly volume percentage of 9 percent of AADT, average threshold daily traffic volumes in the study section were estimated. In this study, the threshold level was set to 600 crossing conflicts based on a typical trend observed in the outcomes of the analysis. The analysis showed that AADT of about 34,000 to 38,000 veh/day would be the demand level where a TWLTL is recommended to be converted into a raised median for the four-lane study section. Also found was that the performance of a raised median might begin deteriorating once AADT becomes approximately 42,000 to 44,000 veh/day for the four-lane segments analyzed in this study. This is the answer to engineer's second question mentioned previously.

#### **7.4 Recommendations**

This study demonstrated that VISSIM simulation models combined with use of SSAM could be a viable tool for evaluating safety effects of access management alternatives. The strength of this approach is that it is less time consuming and less affected by uncertainty inherent to using crash data. An additional strength of this approach is that a comparison of access management alternatives can be performed in the same simulated "physical" environment. These three points were the main issues of traditional crash data based analyses and conflict analyses performed in the field. It is therefore recommended that this approach be further applied

and tested as part of safety analyses of access management alternatives as well as other applications.



## REFERENCES

- Al-Ghandour, M. N., Schroeder, B. J., Williams, B. M., and Rasdorf, W. J. (2011). "Conflict Models for Single-Lane Roundabout Slip Lanes from Microsimulation." *Journal of the Transportation Research Board 2236*, Transportation Research Board, Washington, D.C. 92-101.
- Baker, W. T. (1971). *Evaluating the Traffic Conflicts Technique*. Federal Highway Administration, Washington, D.C.
- Chai, C. and Wong, Y. D. (2015). "Comparison of Two Simulation Approaches to Safety Assessment: Cellular Automata and SSAM." *Journal of Transportation Engineering*, 10.1061/(ASCE)TE.1943-5436.0000766.
- Dijkstra, A., Marchesini, P., Bijleveld, F., Kars, V., Drolenga, H., and van Maarseveen, M. (2010). "Do Calculated Conflicts in a Micro-Simulation Model Predicting the Number of Crashes?" *Journal of the Transportation Research Board 2147*, Transportation Research Board, Washington, D.C., 105-112.
- Essa, M. and Sayed, T. (2015). "Transferability of Calibrated Microsimulation Model Parameters for Safety Assessment Using Simulated Conflicts." *Accident Analysis and Prevention. Elsevier, Vol. 84*, 41-53.
- Federal Highway Administration (FHWA). (2015). "Surrogate Safety Assessment Model (SSAM)" Web site. Office of Research, Development, and Technology. < <https://www.fhwa.dot.gov/research/tfhrc/projects/projectsite/safety/ssam/index.cfm> > (June, 29 2017).

- Gettman, D. and Head, L. (2003). Surrogate Measures of Safety from Traffic Simulation Models. Report No. FHWA-RD-03-050, Federal Highway Administration (FHWA): Washington, D.C.
- Gettman, D., Pu, L., Sayed, T., and Shelby, S. (2008). Surrogate Safety Assessment Model and Validation: Final Report. Business Unit Intelligent Transportation Systems, Tucson, AZ.
- Gettman, D. and Head, L. (2012). Surrogate Safety Measures from Traffic Simulation Models, Final Report. Siemens Gardner Transportation Systems, Tucson, AZ.
- Glennon J. C. and Thorson B. A. (1975). Evaluation of the Traffic Conflicts Technique. Office of Research and Development, Federal Highway Administration, U.S. Department of Transportation, Washington, D.C.
- Habtemichael, F. G. and Santos, L. P. (2014). “Crash Risk evaluation of Aggressive Driving on Motorways: Microscopic Traffic Simulation Approach.” *Transportation Research Part F* 23 (2014) 101-112.
- Huang, F., Liu, P., Yu, H., and Wang, W. (2012). “Identifying if VISSIM simulation model and SSAM provide reasonable estimates for field measured traffic conflicts at signalized intersections.” *Accident Analysis and Prevention*, 50 (2013) 1014 -1024.
- Hummer, F. E., Haley, R. L., Ott, S. E., Foyle, R. S., and Cunningham, C. M. (2010). Superstreet Benefits and Capacities. Department of Civil, Construction and Environmental Engineering, North Carolina State University, Raleigh, NC.
- Institute of Transportation Engineers (ITE). (2008). Trip Generation, an ITE Information Report 8<sup>th</sup> Edition. Institute of Transportation Engineers, Washington, D.C.
- Lee, J., Park, B., Malakorn, K., and So, J. (2011). “Safety Assessment of Cooperative Vehicle Infrastructure System-Based Urban Traffic Control.” *Proc., 3<sup>rd</sup> International Conference on Road Safety and Simulation*, Indianapolis, IN.

- Sabra, Z. A., Gettman, D., Henry, D., and Nallamotheu, V. (2010). Balancing Safety and Capacity in an Adaptive Signal Control System – Phase 1. Sabra, Wang & Associates, Inc, Baltimore, MD.
- Schultz, G. G., and Lewis, J. S. (2006). Assessing the Safety Benefits of Access Management Techniques. Report No. UT-06.08. Research Division, Utah Department of Transportation, Salt Lake City, UT.
- Schultz, G. G., and Braley, K. T. (2007). A Prioritization Process for Access Management Implementation in Utah. Report No. UT-07.05. Research Division, Utah Department of Transportation, Salt Lake City, UT.
- Schultz, G. G., Allen, C. G., and Eggett, D. L. (2008). Crashes in the Vicinity of Major Crossroads. Report No. UT-08.25. Research Division, Utah Department of Transportation, Salt Lake City, UT.
- Schultz, G. G., Thurgood, D. J., Olsen, A. N., and Reese, C. S. (2010). Transportation Safety Data and Analysis, Volume 1: Analyzing the Effectiveness of Safety Measures using Bayesian Methods. Report No. UT-10.12a. Research Division, Utah Department of Transportation, Salt Lake City, UT.
- Schultz, G. G., Seat, M. L., and Saito, M. (2017). Utilizing Lidar Data To Analyze Access Management Criteria In Utah, Report No. UT-17.09. Research Division, Utah Department of Transportation, Salt Lake City, UT.
- So, J., Dedes, G, Park, B., Hosseiny Alamdary, S., and Grejner-Brzezinsk, D. (2014). “Development and evaluation of an enhanced surrogate safety assessment framework.” *Transportation Research Part C* 50 (2015) 51 – 67.
- Stevanovic, A., Stevanovic, J., and Dergaye, C. (2012). “Optimizing signal Timings to Improve Safety of Signalized Arterials.” *Proc., 3<sup>rd</sup> International Conference on Road Safety and Simulation*, Indianapolis, IN.
- Utah Department of Transportation (UDOT). (2016). “Open Data Portal.” < <http://udot.uplan.opendata.arcgis.com/>> (July 2016).

Vasconcelos, L., Neto, L., Seco, A. M., and Silva, A. B. (2014). "Validation of the Surrogate Safety Assessment Model for Assessment of Intersection Safety." *Journal of the Transportation Research Board 2432*, Transportation Research Board, Washington, D.C., 1-9.

Williams, K., Stover, V. G., Dixon, K. K., and Demosthenes, P. (2014). *Access Management Manual*, 2<sup>nd</sup> Ed., Transportation Research Board, Washington, D.C.

Zhou, H. and Huang, F. (2013). "Development of traffic safety evaluation method based on simulated conflicts at signalized intersections." *Procedia – Social and Behavioral Sciences* 96 (2013) 881 - 885.

## APPENDIX A. TRIP DISTRIBUTION

Appendix A is a collection of trip distribution through the Main Street study section in American Fork. These trip distributions were used to model all traffic volume using each access driveway in the Main Street study section.

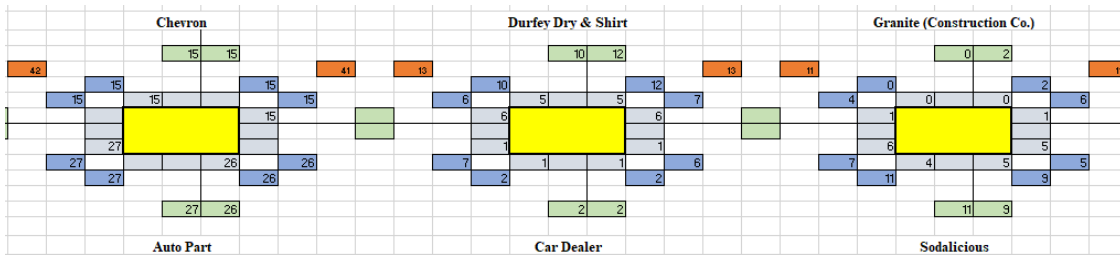


Figure A-1: Trip distribution (1)

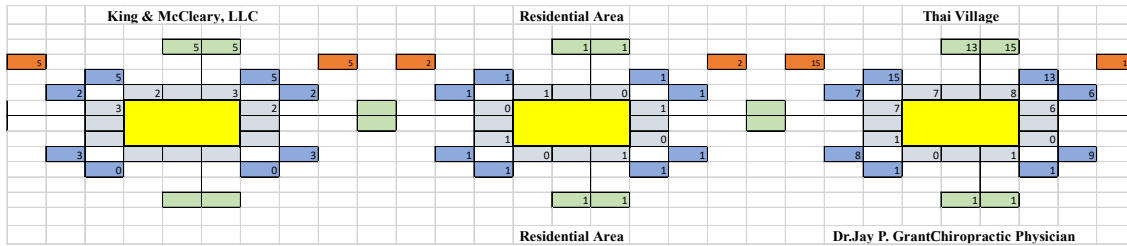


Figure A-2: Trip distribution (2)

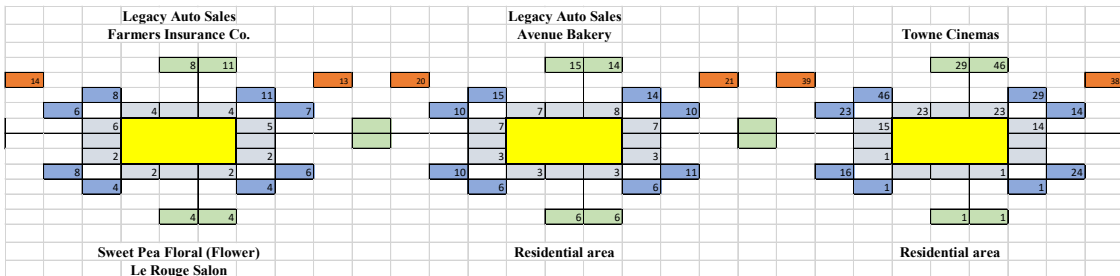
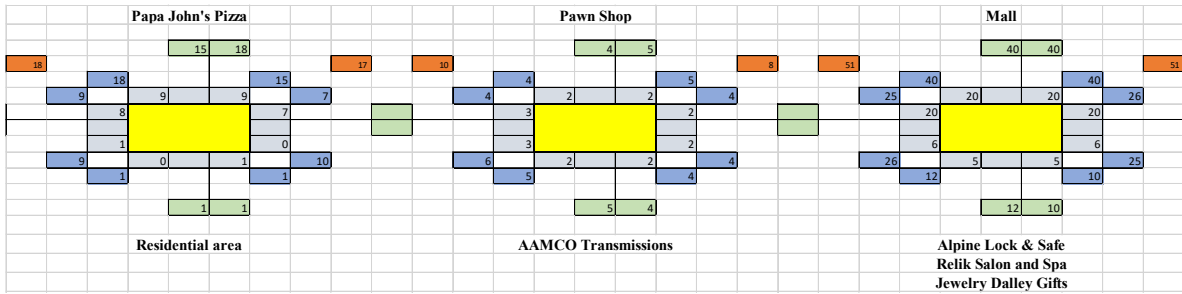
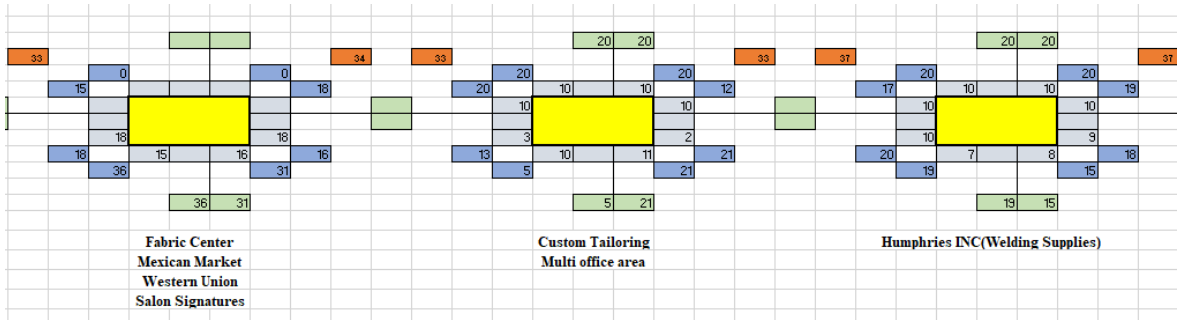


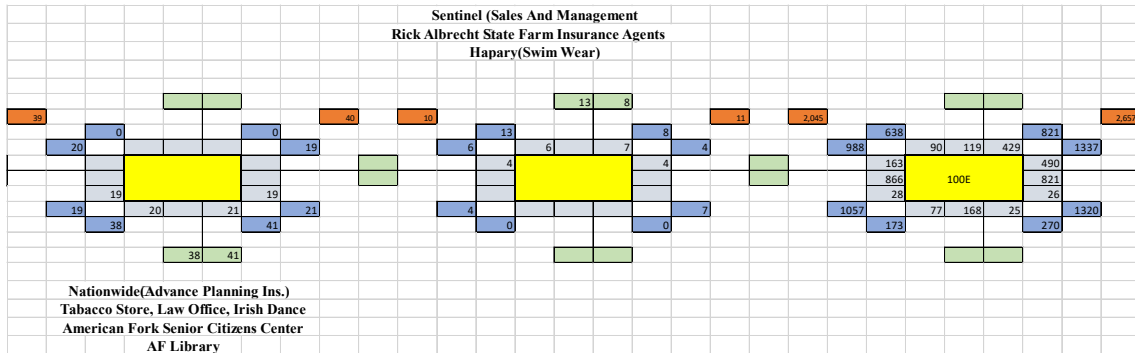
Figure A-3: Trip distribution (3)



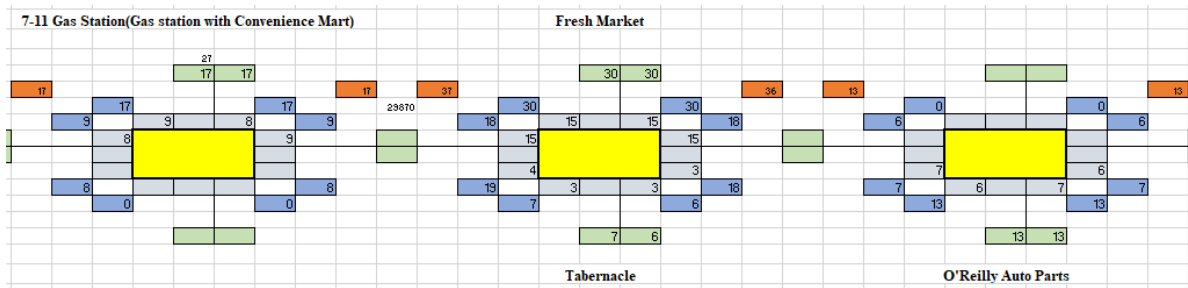
**Figure A-4: Trip distribution (4)**



**Figure A-5: Trip distribution (5)**



**Figure A-6: Trip distribution (6)**



**Figure A-7: Trip distribution (7)**

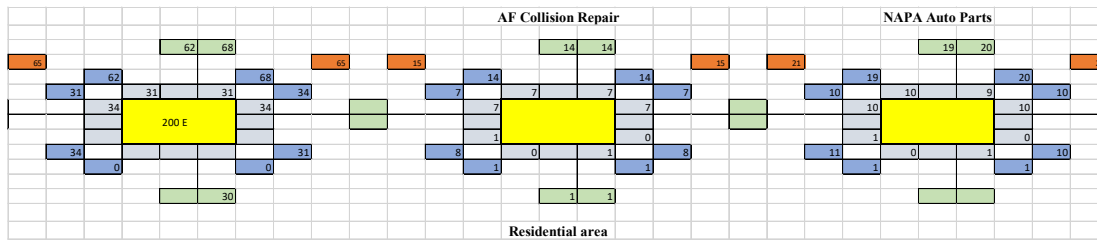


Figure A-8: Trip distribution (8)

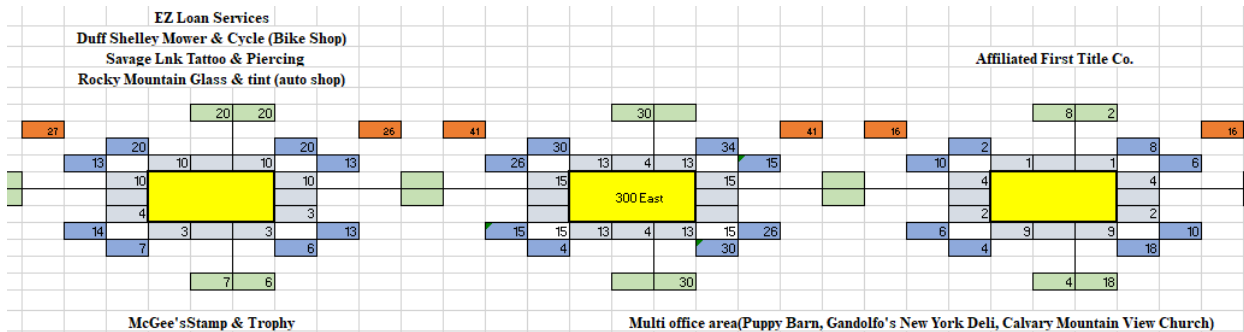


Figure A-9: Trip distribution (9)

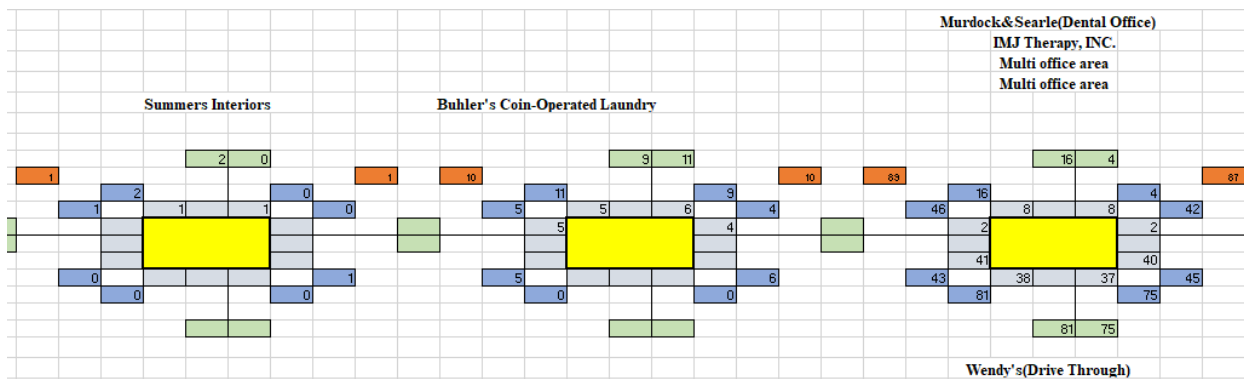


Figure A-10: Trip distribution (10)

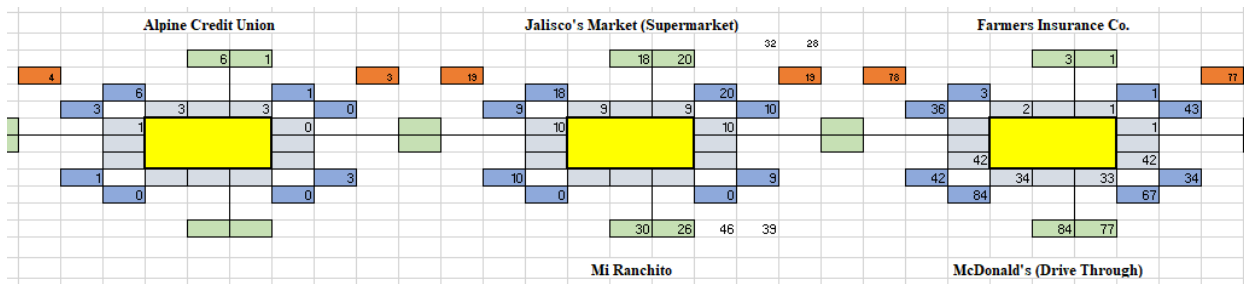


Figure A-11: Trip distribution (11)

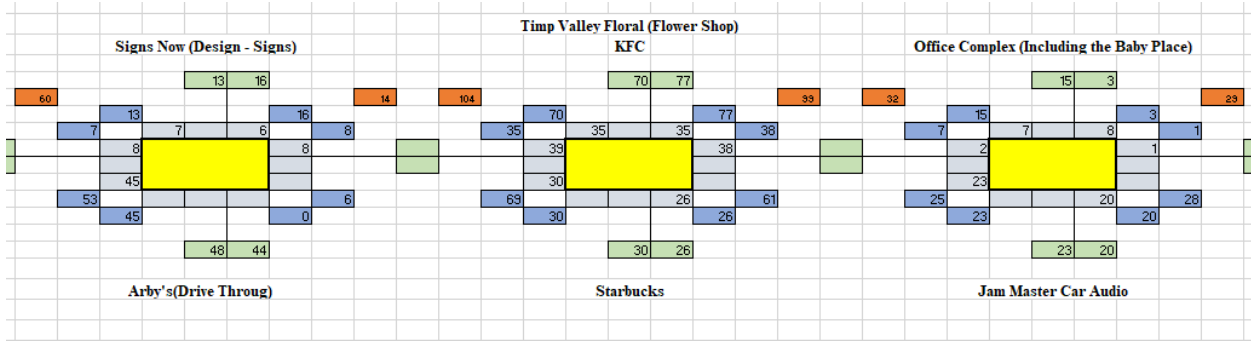


Figure A-12: Trip distribution (12)

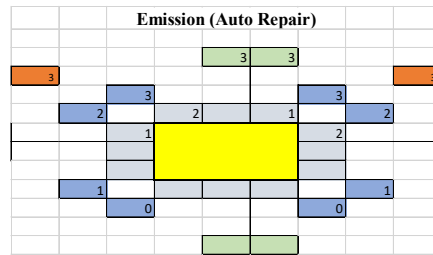
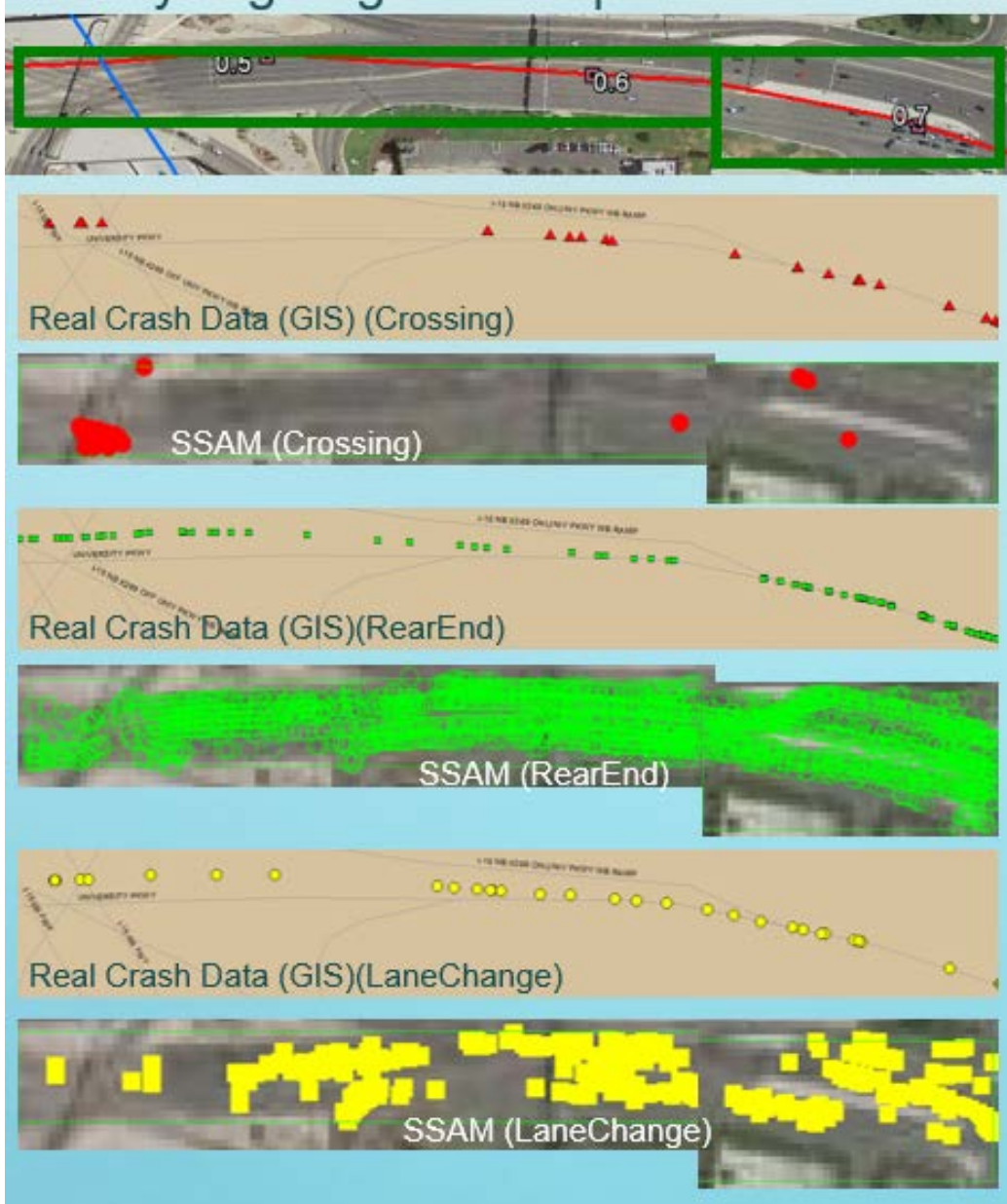


Figure A-13: Trip distribution (13)



## **APPENDIX B. SPATIAL ANALYSIS RESULTS OF UNIVERSITY PARKWAY**

Appendix B is a collection of spatial analysis results of University Parkway. These results are used to compare the SSAM spatial analysis results to real crash data location to estimate any similarity.



**Figure B-1: Segment 1**

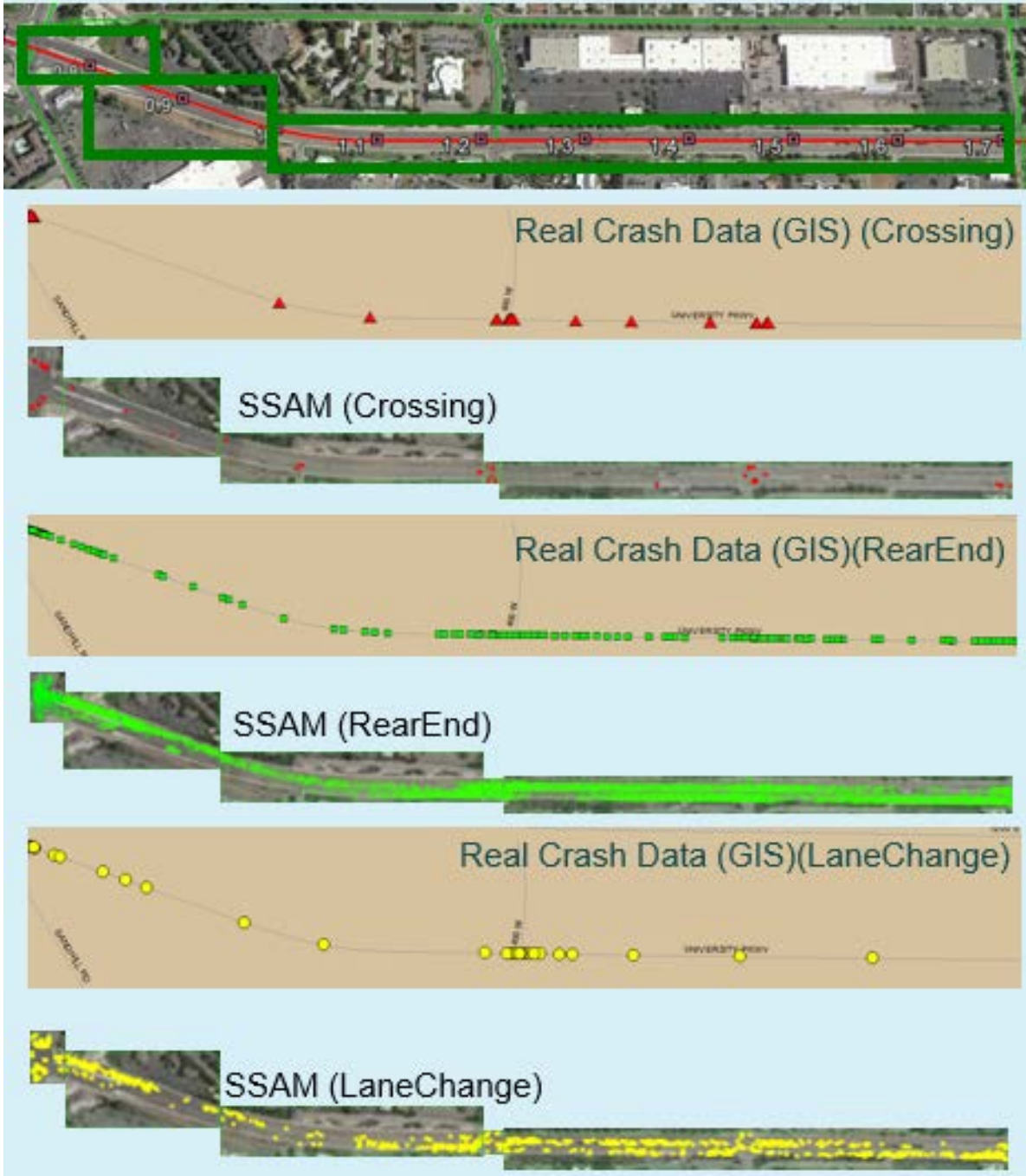


Figure B-2: Segment 2



Figure B-3: Segment 3



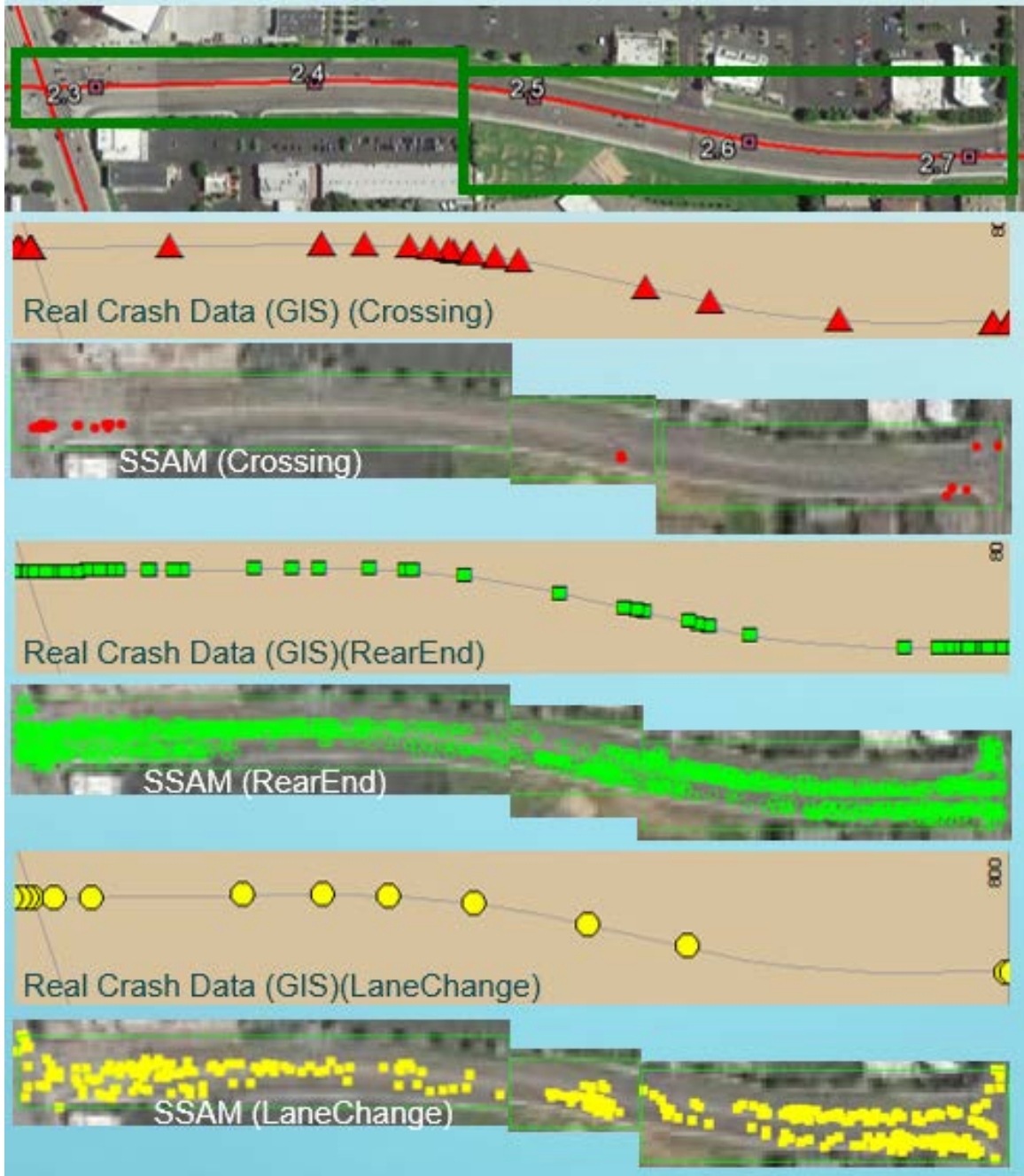
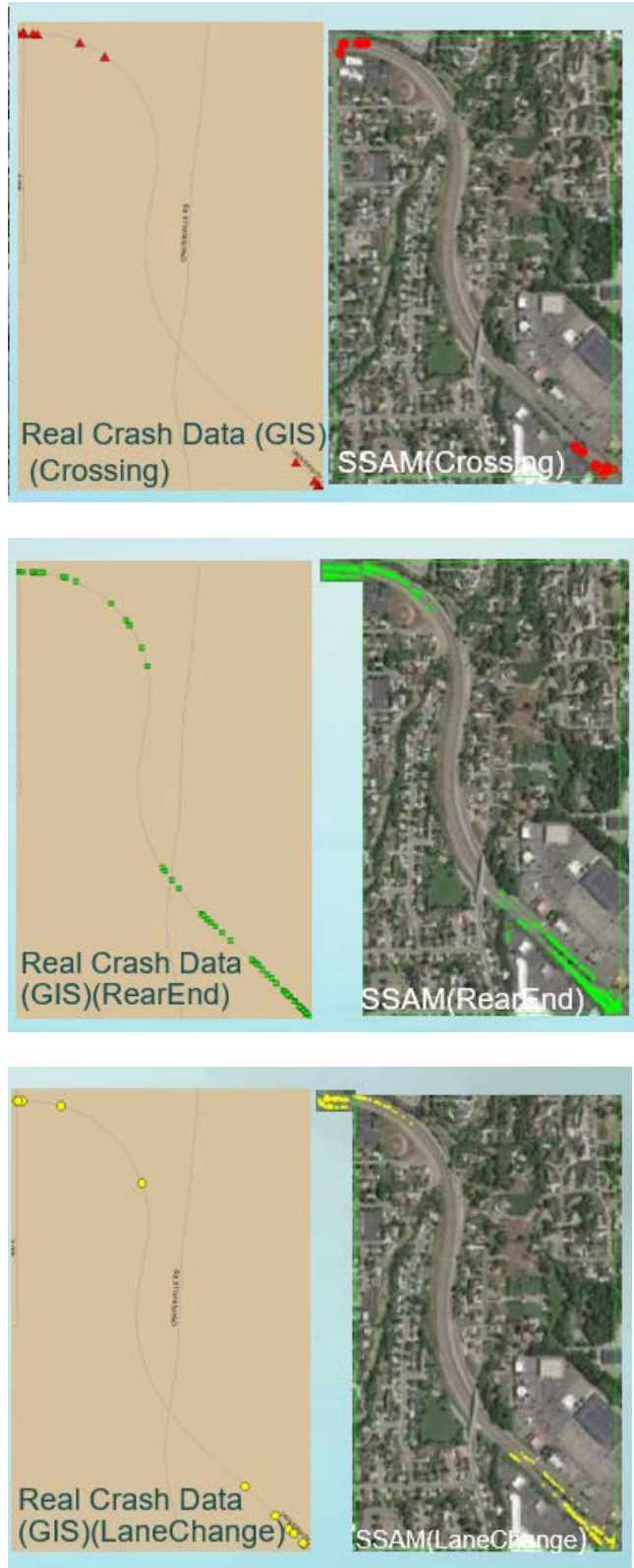
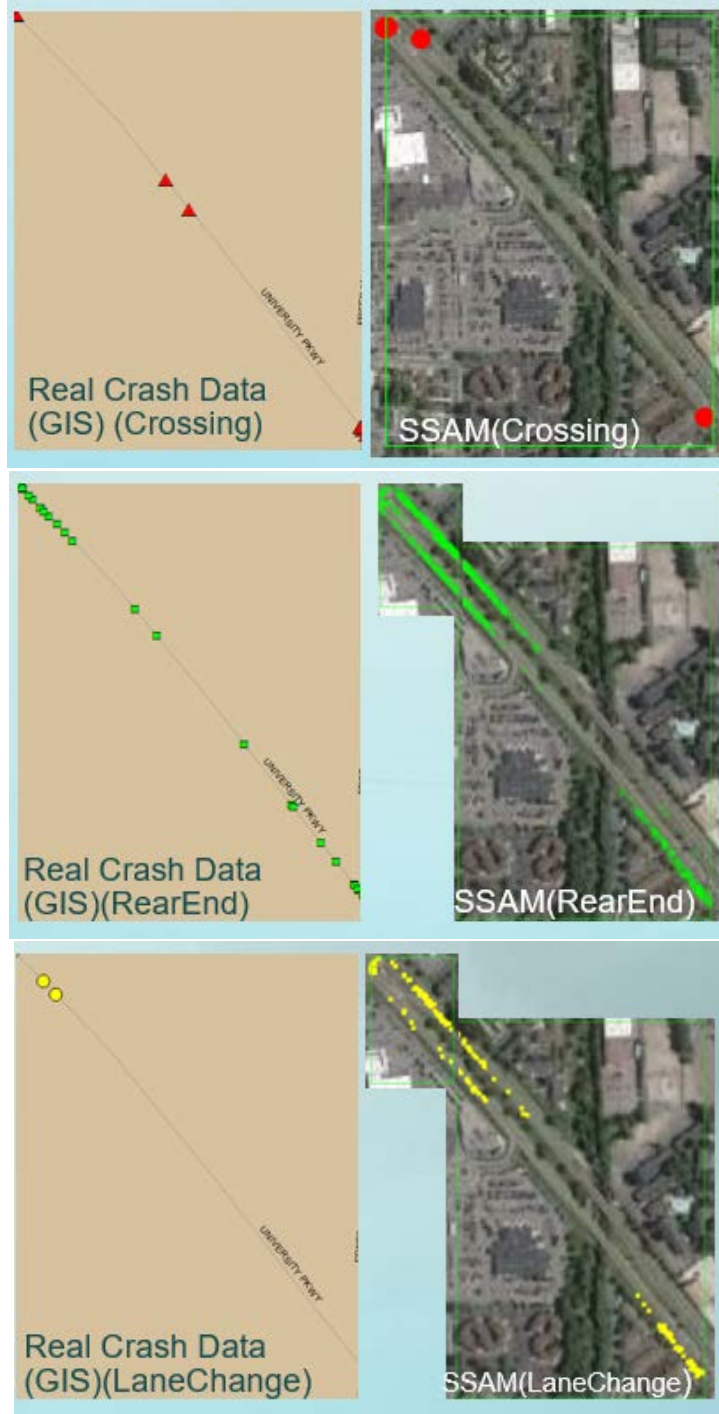


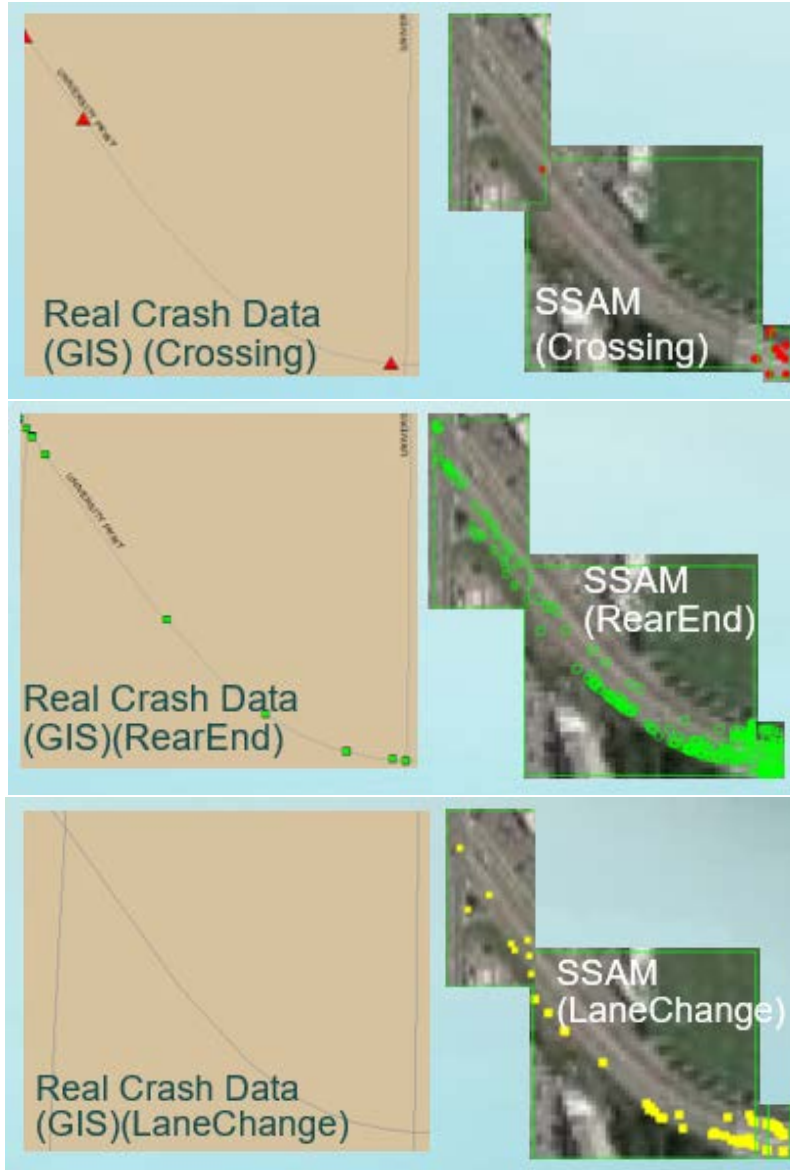
Figure B-4: Segment 4



**Figure B-5: Segment 5**



**Figure B-6: Segment 6**



**Figure B-7: Segment 7**



## **APPENDIX C. NUMBER OF CONFLICTS BY CONFLICT TYPE DETERMINED FOR MAIN STREET STUDY SECTION**

Appendix C is a collection of number of conflicts by conflict type determined for the Main Street study section. These results are used to find out main factor to cause the majority of differences in the number of conflicts between a TWLTL median and a raised median.

**Table C-1: Segment 1 TWLTL**

Main	Side	Runs (Crossing)				Main	Side	Runs (RearEnd)			
		1st	2nd	3rd	Ave.			1st	2nd	3rd	Ave.
1.0	1.0	92.0	102.0	93.0	95.7	1.0	1.0	824.0	817.0	746.0	795.7
	1.1	123.0	131.0	130.0	128.0		1.1	891.0	906.0	784.0	860.3
	1.2	138.0	132.0	98.0	122.7		1.2	951.0	914.0	867.0	910.7
	1.3	145.0	144.0	144.0	144.3		1.3	1044.0	946.0	903.0	964.3
	1.4	167.0	166.0	154.0	162.3		1.4	1143.0	1065.0	958.0	1055.3
1.1	1.0	109.0	114.0	108.0	110.3	1.1	1.0	954.0	949.0	889.0	930.7
	1.1	130.0	130.0	103.0	121.0		1.1	1071.0	1015.0	890.0	992.0
	1.2	140.0	146.0	125.0	137.0		1.2	1102.0	1056.0	914.0	1024.0
	1.3	165.0	149.0	203.0	172.3		1.3	1203.0	1145.0	1148.0	1165.3
	1.4	161.0	1273.0	230.0	554.7		1.4	1318.0	2723.0	1191.0	1744.0
1.2	1.0	126.0	116.0	108.0	116.7	1.2	1.0	1085.0	1190.0	1051.0	1108.7
	1.1	147.0	1229.0	125.0	500.3		1.1	1202.0	891.0	965.0	1019.3
	1.2	152.0	170.0	728.0	350.0		1.2	1316.0	1154.0	935.0	1135.0
	1.3	175.0	174.0	175.0	174.7		1.3	1344.0	1316.0	1276.0	1312.0
	1.4	189.0	228.0	208.0	208.3		1.4	1443.0	1430.0	1371.0	1414.7
1.3	1.0	147.0	128.0	180.0	151.7	1.3	1.0	1407.0	1203.0	1190.0	1266.7
	1.1	130.0	167.0	162.0	153.0		1.1	1346.0	1306.0	1219.0	1290.3
	1.2	160.0	237.0	198.0	198.3		1.2	1365.0	1430.0	1299.0	1364.7
	1.3	179.0	206.0	375.0	253.3		1.3	1629.0	1536.0	1759.0	1641.3
	1.4	185.0	158.0	209.0	184.0		1.4	1671.0	1624.0	1666.0	1653.7
1.4	1.0	206.0	205.0	357.0	256.0	1.4	1.0	1776.0	1492.0	1964.0	1744.0
	1.1	140.0	155.0	173.0	156.0		1.1	1569.0	1388.0	1340.0	1432.3
	1.2	185.0	200.0	207.0	197.3		1.2	1594.0	1584.0	1549.0	1575.7
	1.3	300.0	174.0	555.0	343.0		1.3	2090.0	1635.0	2594.0	2106.3
	1.4	246.0	220.0	298.0	254.7		1.4	1986.0	1898.0	2269.0	2051.0

Main	Side	Runs (Crossing)				Main	Side	Runs (RearEnd)			
		1st	2nd	3rd	Ave.			1st	2nd	3rd	Ave.
1.0	1.0	92.0	102.0	93.0	95.7	1.0	1.0	824.0	817.0	746.0	795.7
	1.1	123.0	131.0	130.0	128.0		1.1	891.0	906.0	784.0	860.3
	1.2	138.0	132.0	98.0	122.7		1.2	951.0	914.0	867.0	910.7
	1.3	145.0	144.0	144.0	144.3		1.3	1044.0	946.0	903.0	964.3
	1.4	167.0	166.0	154.0	162.3		1.4	1143.0	1065.0	958.0	1055.3
1.1	1.0	109.0	114.0	108.0	110.3	1.1	1.0	954.0	949.0	889.0	930.7
	1.1	130.0	130.0	103.0	121.0		1.1	1071.0	1015.0	890.0	992.0
	1.2	140.0	146.0	125.0	137.0		1.2	1102.0	1056.0	914.0	1024.0
	1.3	165.0	149.0	203.0	172.3		1.3	1203.0	1145.0	1148.0	1165.3
	1.4	161.0	1273.0	230.0	554.7		1.4	1318.0	2723.0	1191.0	1744.0
1.2	1.0	126.0	116.0	108.0	116.7	1.2	1.0	1085.0	1190.0	1051.0	1108.7
	1.1	147.0	1229.0	125.0	500.3		1.1	1202.0	891.0	965.0	1019.3
	1.2	152.0	170.0	728.0	350.0		1.2	1316.0	1154.0	935.0	1135.0
	1.3	175.0	174.0	175.0	174.7		1.3	1344.0	1316.0	1276.0	1312.0
	1.4	189.0	228.0	208.0	208.3		1.4	1443.0	1430.0	1371.0	1414.7
1.3	1.0	147.0	128.0	180.0	151.7	1.3	1.0	1407.0	1203.0	1190.0	1266.7
	1.1	130.0	167.0	162.0	153.0		1.1	1346.0	1306.0	1219.0	1290.3
	1.2	160.0	237.0	198.0	198.3		1.2	1365.0	1430.0	1299.0	1364.7
	1.3	179.0	206.0	375.0	253.3		1.3	1629.0	1536.0	1759.0	1641.3
	1.4	185.0	158.0	209.0	184.0		1.4	1671.0	1624.0	1666.0	1653.7
1.4	1.0	206.0	205.0	357.0	256.0	1.4	1.0	1776.0	1492.0	1964.0	1744.0
	1.1	140.0	155.0	173.0	156.0		1.1	1569.0	1388.0	1340.0	1432.3
	1.2	185.0	200.0	207.0	197.3		1.2	1594.0	1584.0	1549.0	1575.7
	1.3	300.0	174.0	555.0	343.0		1.3	2090.0	1635.0	2594.0	2106.3
	1.4	246.0	220.0	298.0	254.7		1.4	1986.0	1898.0	2269.0	2051.0

**Table C-2: Segment 2 TWLTL**

Main	Side	Runs (Crossing)				Main	Side	Runs (RearEnd)			
		1st	2nd	3rd	Ave.			1st	2nd	3rd	Ave.
1.0	1.0	176.0	192.0	168.0	178.7	1.0	1.0	1655.0	1740.0	1940.0	1778.3
	1.1	232.0	263.0	334.0	276.3		1.1	2010.0	2274.0	2503.0	2262.3
	1.2	300.0	252.0	274.0	275.3		1.2	2340.0	2436.0	2793.0	2523.0
	1.3	389.0	405.0	459.0	417.7		1.3	2754.0	3137.0	3173.0	3021.3
	1.4	510.0	484.0	797.0	597.0		1.4	3383.0	3429.0	4527.0	3779.7
1.1	1.0	229.0	267.0	284.0	260.0	1.1	1.0	2327.0	2651.0	2788.0	2588.7
	1.1	278.0	287.0	373.0	312.7		1.1	2465.0	2760.0	2721.0	2648.7
	1.2	472.0	422.0	640.0	511.3		1.2	2911.0	3535.0	4079.0	3508.3
	1.3	694.0	845.0	856.0	798.3		1.3	3699.0	4897.0	5065.0	4553.7
	1.4	847.0	1593.0	1085.0	1175.0		1.4	5041.0	5591.0	5858.0	5496.7
1.2	1.0	355.0	541.0	744.0	546.7	1.2	1.0	3326.0	4510.0	4978.0	4271.3
	1.1	379.0	1083.0	777.0	746.3		1.1	3133.0	2760.0	4363.0	3418.7
	1.2	656.0	682.0	1435.0	924.3		1.2	4164.0	5654.0	4737.0	4851.7
	1.3	936.0	1125.0	1225.0	1095.3		1.3	4942.0	5366.0	6064.0	5457.3
	1.4	1317.0	1087.0	1432.0	1278.7		1.4	5983.0	5892.0	6162.0	6012.3
1.3	1.0	891.0	995.0	1264.0	1050.0	1.3	1.0	6246.0	5464.0	6078.0	5929.3
	1.1	803.0	982.0	698.0	827.7		1.1	4171.0	4843.0	4259.0	4424.3
	1.2	767.0	1015.0	755.0	845.7		1.2	5209.0	5958.0	4928.0	5365.0
	1.3	1152.0	1177.0	1586.0	1305.0		1.3	5752.0	6029.0	6650.0	6143.7
	1.4	1286.0	1409.0	1372.0	1355.7		1.4	6138.0	6407.0	7448.0	6664.3
1.4	1.0	772.0	1557.0	1166.0	1165.0	1.4	1.0	5804.0	5738.0	5759.0	5767.0
	1.1	711.0	1053.0	693.0	819.0		1.1	4979.0	6355.0	5160.0	5498.0
	1.2	948.0	1498.0	1057.0	1167.7		1.2	6001.0	6218.0	6920.0	6379.7
	1.3	1187.0	1430.0	1460.0	1359.0		1.3	6214.0	6989.0	7225.0	6809.3
	1.4	1229.0	1229.0	1275.0	1244.3		1.4	6014.0	6743.0	7086.0	6614.3
Main	Side	Runs (LaneChange)				Main	Side	Runs (Total)			
		1st	2nd	3rd	Ave.			1st	2nd	3rd	Ave.
1.0	1.0	358.0	397.0	422.0	392.3	1.0	1.0	2189.0	2329.0	2530.0	2349.3
	1.1	479.0	508.0	549.0	512.0		1.1	2721.0	3045.0	3386.0	3050.7
	1.2	473.0	522.0	587.0	527.3		1.2	3113.0	3210.0	3654.0	3325.7
	1.3	615.0	622.0	647.0	628.0		1.3	3758.0	4164.0	4279.0	4067.0
	1.4	784.0	728.0	1015.0	842.3		1.4	4677.0	4641.0	6339.0	5219.0
1.1	1.0	493.0	544.0	572.0	536.3	1.1	1.0	3049.0	3462.0	3644.0	3385.0
	1.1	542.0	574.0	628.0	581.3		1.1	3285.0	3621.0	3722.0	3542.7
	1.2	665.0	726.0	873.0	754.7		1.2	4048.0	4683.0	5592.0	4774.3
	1.3	701.0	956.0	1062.0	906.3		1.3	5094.0	6698.0	6983.0	6258.3
	1.4	1234.0	1350.0	1298.0	1294.0		1.4	7122.0	8534.0	8241.0	7965.7
1.2	1.0	751.0	939.0	985.0	891.7	1.2	1.0	4432.0	5990.0	6707.0	5709.7
	1.1	689.0	633.0	946.0	756.0		1.1	4201.0	4476.0	6086.0	4921.0
	1.2	909.0	1222.0	927.0	1019.3		1.2	5729.0	7558.0	7099.0	6795.3
	1.3	1382.0	1000.0	1357.0	1246.3		1.3	7260.0	7491.0	8646.0	7799.0
	1.4	1321.0	1161.0	1555.0	1345.7		1.4	8621.0	8140.0	9149.0	8636.7
1.3	1.0	1661.0	1262.0	1347.0	1423.3	1.3	1.0	8798.0	7721.0	8689.0	8402.7
	1.1	897.0	935.0	1026.0	952.7		1.1	5871.0	6760.0	5983.0	6204.7
	1.2	1238.0	1330.0	1077.0	1215.0		1.2	7214.0	8303.0	6760.0	7425.7
	1.3	1372.0	1298.0	1688.0	1452.7		1.3	8276.0	8504.0	9924.0	8901.3
	1.4	1341.0	1478.0	1852.0	1557.0		1.4	8765.0	9294.0	10672.0	9577.0
1.4	1.0	1169.0	1321.0	1402.0	1297.3	1.4	1.0	7745.0	8616.0	8327.0	8229.3
	1.1	1043.0	1381.0	1975.0	1466.3		1.1	6733.0	8789.0	7828.0	7783.3
	1.2	1481.0	1393.0	1810.0	1561.3		1.2	8430.0	9109.0	9787.0	9108.7
	1.3	1745.0	1655.0	1741.0	1713.7		1.3	9146.0	10074.0	10426.0	9882.0
	1.4	1646.0	1449.0	1790.0	1628.3		1.4	8889.0	9421.0	10151.0	9487.0

**Table C-3: Segment 1 Raised Median**

Main	Side	Runs (Crossing)				Main	Side	Runs (RearEnd)			
		1st	2nd	3rd	Ave.			1st	2nd	3rd	Ave.
1.0	1.0	45.0	38.0	36.0	39.7	1.0	1.0	979.0	1032.0	921.0	977.3
	1.1	65.0	65.0	44.0	58.0		1.1	1126.0	1057.0	1016.0	1066.3
	1.2	61.0	56.0	63.0	60.0		1.2	1208.0	1095.0	1123.0	1142.0
	1.3	76.0	72.0	50.0	66.0		1.3	1251.0	1338.0	1168.0	1252.3
	1.4	87.0	66.0	67.0	73.3		1.4	1455.0	1383.0	1316.0	1384.7
1.1	1.0	41.0	58.0	55.0	51.3	1.1	1.0	1218.0	1067.0	1023.0	1102.7
	1.1	68.0	59.0	55.0	60.7		1.1	1284.0	1230.0	1095.0	1203.0
	1.2	65.0	74.0	58.0	65.7		1.2	1356.0	1293.0	1138.0	1262.3
	1.3	63.0	63.0	66.0	64.0		1.3	1384.0	1381.0	1269.0	1344.7
	1.4	85.0	82.0	79.0	82.0		1.4	1617.0	1643.0	1423.0	1561.0
1.2	1.0	69.0	51.0	65.0	61.7	1.2	1.0	1320.0	1271.0	1201.0	1264.0
	1.1	65.0	63.0	69.0	65.7		1.1	1405.0	1362.0	1191.0	1319.3
	1.2	64.0	56.0	72.0	64.0		1.2	1512.0	1417.0	1317.0	1415.3
	1.3	90.0	311.0	101.0	167.3		1.3	1715.0	1424.0	1703.0	1614.0
	1.4	74.0	179.0	88.0	113.7		1.4	1812.0	1958.0	1654.0	1808.0
1.3	1.0	61.0	52.0	55.0	56.0	1.3	1.0	1412.0	1312.0	1363.0	1362.3
	1.1	144.0	81.0	65.0	96.7		1.1	1656.0	1536.0	1454.0	1548.7
	1.2	67.0	109.0	64.0	80.0		1.2	1720.0	1719.0	1669.0	1702.7
	1.3	79.0	447.0	128.0	218.0		1.3	1831.0	1176.0	1593.0	1533.3
	1.4	95.0	439.0	55.0	196.3		1.4	2146.0	1043.0	2040.0	1743.0
1.4	1.0	67.0	456.0	62.0	195.0	1.4	1.0	1575.0	940.0	1589.0	1368.0
	1.1	403.0	369.0	69.0	280.3		1.1	1929.0	1849.0	1640.0	1806.0
	1.2	486.0	457.0	101.0	348.0		1.2	1437.0	1211.0	1976.0	1541.3
	1.3	488.0	365.0	131.0	328.0		1.3	1611.0	1178.0	1516.0	1435.0
	1.4	162.0	101.0	167.0	143.3		1.4	1353.0	2399.0	1589.0	1780.3

Main	Side	Runs (LaneChange)				Main	Side	Runs (Total)			
		1st	2nd	3rd	Ave.			1st	2nd	3rd	Ave.
1.0	1.0	229.0	241.0	183.0	217.7	1.0	1.0	1253.0	1311.0	1140.0	1234.7
	1.1	240.0	258.0	209.0	235.7		1.1	1431.0	1380.0	1269.0	1360.0
	1.2	281.0	259.0	211.0	250.3		1.2	1550.0	1410.0	1397.0	1452.3
	1.3	272.0	262.0	234.0	256.0		1.3	1599.0	1672.0	1452.0	1574.3
	1.4	286.0	288.0	253.0	275.7		1.4	1828.0	1737.0	1636.0	1733.7
1.1	1.0	253.0	283.0	237.0	257.7	1.1	1.0	1512.0	1408.0	1315.0	1411.7
	1.1	252.0	248.0	218.0	239.3		1.1	1604.0	1537.0	1368.0	1503.0
	1.2	270.0	261.0	255.0	262.0		1.2	1691.0	1628.0	1451.0	1590.0
	1.3	299.0	304.0	288.0	297.0		1.3	1746.0	1748.0	1623.0	1705.7
	1.4	343.0	329.0	320.0	330.7		1.4	2045.0	2054.0	1822.0	1973.7
1.2	1.0	266.0	310.0	262.0	279.3	1.2	1.0	1655.0	1632.0	1528.0	1605.0
	1.1	293.0	271.0	266.0	276.7		1.1	1763.0	1696.0	1526.0	1661.7
	1.2	327.0	296.0	300.0	307.7		1.2	1903.0	1769.0	1689.0	1787.0
	1.3	349.0	425.0	285.0	353.0		1.3	2154.0	2160.0	2089.0	2134.3
	1.4	372.0	387.0	324.0	361.0		1.4	2258.0	2524.0	2066.0	2282.7
1.3	1.0	319.0	307.0	288.0	304.7	1.3	1.0	1792.0	1671.0	1706.0	1723.0
	1.1	342.0	332.0	341.0	338.3		1.1	2142.0	1949.0	1860.0	1983.7
	1.2	360.0	358.0	322.0	346.7		1.2	2147.0	2186.0	2055.0	2129.3
	1.3	327.0	277.0	319.0	307.7		1.3	2237.0	1900.0	2040.0	2059.0
	1.4	416.0	217.0	348.0	327.0		1.4	2657.0	1699.0	2443.0	2266.3
1.4	1.0	331.0	170.0	321.0	274.0	1.4	1.0	1973.0	1566.0	1972.0	1837.0
	1.1	403.0	431.0	302.0	378.7		1.1	2735.0	2649.0	2011.0	2465.0
	1.2	259.0	247.0	331.0	279.0		1.2	2182.0	1915.0	2408.0	2168.3
	1.3	317.0	216.0	267.0	266.7		1.3	2416.0	1759.0	1914.0	2029.7
	1.4	259.0	383.0	292.0	311.3		1.4	1774.0	2883.0	2048.0	2235.0

**Table C-4: Segment 2 Raised Median**

Main	Side	Runs (Crossing)				Main	Side	Runs (RearEnd)			
		1st	2nd	3rd	Ave.			1st	2nd	3rd	Ave.
1.0	1.0	134.0	139.0	117.0	130.0	1.0	1.0	1638.0	1840.0	1911.0	1796.3
	1.1	168.0	109.0	170.0	149.0		1.1	1678.0	1917.0	2039.0	1878.0
	1.2	198.0	170.0	163.0	177.0		1.2	2018.0	2126.0	2151.0	2098.3
	1.3	244.0	193.0	232.0	223.0		1.3	2247.0	2410.0	2411.0	2356.0
	1.4	256.0	218.0	210.0	228.0		1.4	2303.0	2469.0	2597.0	2456.3
1.1	1.0	149.0	151.0	146.0	148.7	1.1	1.0	2039.0	2139.0	2156.0	2111.3
	1.1	186.0	177.0	196.0	186.3		1.1	2163.0	2196.0	2288.0	2215.7
	1.2	201.0	216.0	347.0	254.7		1.2	2294.0	2394.0	2755.0	2481.0
	1.3	218.0	284.0	271.0	257.7		1.3	2609.0	2955.0	2931.0	2831.7
	1.4	278.0	313.0	349.0	313.3		1.4	2658.0	2900.0	3402.0	2986.7
1.2	1.0	179.0	175.0	167.0	173.7	1.2	1.0	2563.0	2442.0	2482.0	2495.7
	1.1	177.0	233.0	198.0	202.7		1.1	2388.0	2604.0	2524.0	2505.3
	1.2	233.0	221.0	335.0	263.0		1.2	2974.0	3069.0	3632.0	3225.0
	1.3	365.0	414.0	463.0	414.0		1.3	3423.0	3165.0	4382.0	3656.7
	1.4	304.0	703.0	724.0	577.0		1.4	3312.0	4407.0	4260.0	3993.0
1.3	1.0	233.0	295.0	224.0	250.7	1.3	1.0	2792.0	3281.0	2861.0	2978.0
	1.1	501.0	290.0	339.0	376.7		1.1	3636.0	3656.0	3535.0	3609.0
	1.2	376.0	403.0	658.0	479.0		1.2	3530.0	3959.0	4221.0	3903.3
	1.3	526.0	1051.0	934.0	837.0		1.3	4377.0	3633.0	2913.0	3641.0
	1.4	893.0	552.0	866.0	770.3		1.4	4410.0	2915.0	4471.0	3932.0
1.4	1.0	410.0	599.0	400.0	469.7	1.4	1.0	3719.0	2748.0	3854.0	3440.3
	1.1	929.0	845.0	635.0	803.0		1.1	4332.0	4109.0	3945.0	4128.7
	1.2	809.0	794.0	796.0	799.7		1.2	3833.0	3148.0	3584.0	3521.7
	1.3	1130.0	1018.0	567.0	905.0		1.3	3893.0	3613.0	2739.0	3415.0
	1.4	327.0	776.0	443.0	515.3		1.4	1649.0	3855.0	2563.0	2689.0

Main	Side	Runs (LaneChange)				Main	Side	Runs (Total)			
		1st	2nd	3rd	Ave.			1st	2nd	3rd	Ave.
1.0	1.0	394.0	422.0	412.0	409.3	1.0	1.0	2166.0	2401.0	2440.0	2335.7
	1.1	439.0	458.0	511.0	469.3		1.1	2285.0	2484.0	2720.0	2496.3
	1.2	454.0	514.0	566.0	511.3		1.2	2670.0	2810.0	2880.0	2786.7
	1.3	525.0	542.0	548.0	538.3		1.3	3016.0	3145.0	3191.0	3117.3
	1.4	578.0	578.0	617.0	591.0		1.4	3137.0	3265.0	3424.0	3275.3
1.1	1.0	501.0	485.0	502.0	496.0	1.1	1.0	2689.0	2775.0	2804.0	2756.0
	1.1	508.0	494.0	565.0	522.3		1.1	2857.0	2867.0	3049.0	2924.3
	1.2	547.0	562.0	624.0	577.7		1.2	3042.0	3172.0	3726.0	3313.3
	1.3	606.0	663.0	663.0	644.0		1.3	3433.0	3902.0	3865.0	3733.3
	1.4	621.0	614.0	776.0	670.3		1.4	3557.0	3827.0	4527.0	3970.3
1.2	1.0	606.0	573.0	645.0	608.0	1.2	1.0	3348.0	3190.0	3294.0	3277.3
	1.1	571.0	585.0	589.0	581.7		1.1	3136.0	3422.0	3311.0	3289.7
	1.2	690.0	691.0	765.0	715.3		1.2	3897.0	3981.0	4732.0	4203.3
	1.3	705.0	680.0	1098.0	827.7		1.3	4493.0	4259.0	5943.0	4898.3
	1.4	737.0	935.0	1033.0	901.7		1.4	4353.0	6045.0	6017.0	5471.7
1.3	1.0	606.0	736.0	734.0	692.0	1.3	1.0	3631.0	4312.0	3819.0	3920.7
	1.1	904.0	828.0	842.0	858.0		1.1	5041.0	4774.0	4716.0	4843.7
	1.2	821.0	834.0	962.0	872.3		1.2	4727.0	5196.0	5841.0	5254.7
	1.3	966.0	636.0	1053.0	885.0		1.3	5869.0	5320.0	4900.0	5363.0
	1.4	940.0	602.0	1015.0	852.3		1.4	6243.0	4069.0	6352.0	5554.7
1.4	1.0	778.0	604.0	970.0	784.0	1.4	1.0	4907.0	3951.0	5224.0	4694.0
	1.1	1130.0	957.0	912.0	999.7		1.1	6391.0	5911.0	5492.0	5931.3
	1.2	729.0	860.0	1018.0	869.0		1.2	5371.0	4802.0	5398.0	5190.3
	1.3	752.0	824.0	765.0	780.3		1.3	5775.0	5455.0	4071.0	5100.3
	1.4	424.0	895.0	835.0	718.0		1.4	2400.0	5526.0	3841.0	3922.3

## APPENDIX D. NUMBER OF CONFLICTS BY CONFLICT TYPE DETERMINED FOR MAIN STREET STUDY SECTION

### D.1 Rear-end Conflicts

Figure D-1 shows the results of the threshold traffic volume analysis for rear-end conflicts of TWLTL and raised medians. With the threshold of rear-end conflicts in Segment 2 being set to approximately 4,000, traffic volumes on or near the cyan-colored contour were determined and they were found to be approximately 780 to 864 vehicles per hour per lane. With the raised median, traffic volumes on or near the cyan-colored contour were determined to be 864 to 919 vehicles per hour per lane. The raised median can accommodate 0 to 139 vehicles per hour per lane more to reach the same level of rear-end conflicts for the TWLTL median.

Knowing that the study segments have four lanes (a total of the number of lanes in both directions), the threshold traffic volume to convert a TWLTL median to a raised median would be approximately 3,120 to 3,460 vehicles per hour ( $780 \times 4 = 3,120$  and  $864 \times 4 = 3,456$  as shown in Figure D-1). Since the percentage of the current PM peak hourly volume against AADT for Main Street in the study area is about 9 percent (this percentage was estimated using the traffic volume used in the VISSIM model provided by UDOT and AADT data available from UDOT for year 2014), the threshold AADT for considering the conversion of a TWLTL median to a raised median would be approximately 34,700 to 38,400 veh/day for the four lanes in Segment 2 (two lanes in each direction). A raised median may begin to have a similar level of



rear-end conflicts as the one for TWLTL when the hourly volume becomes approximately 3,456 to 3,676 vehicles per hour ( $864 \times 4 = 3,456$  and  $919 \times 4 = 3,676$  as shown in Figure D-1). With these hourly values, the AADT where a raised median might begin to have an increase in the number of rear-end conflicts similar to the TWLTL median would be approximately 38,400 to 40,800 veh/day for the four lanes on Segment 2 of this study section.

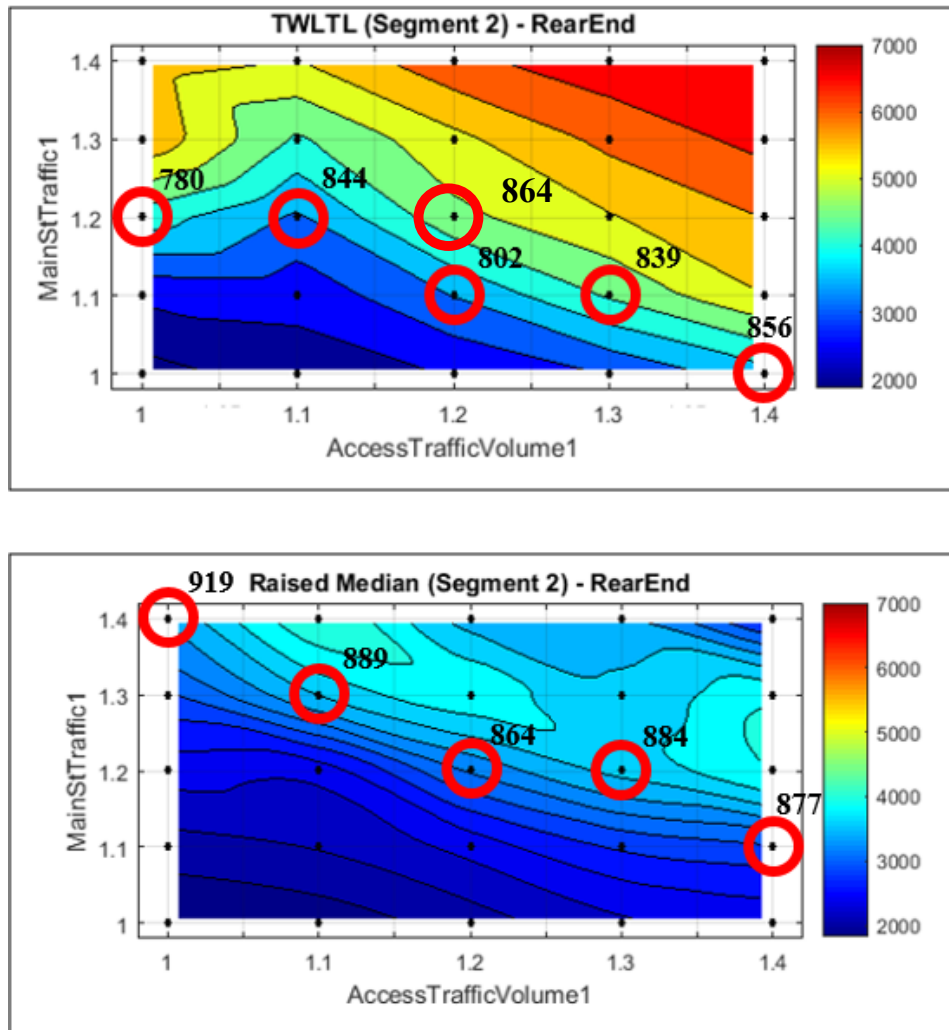


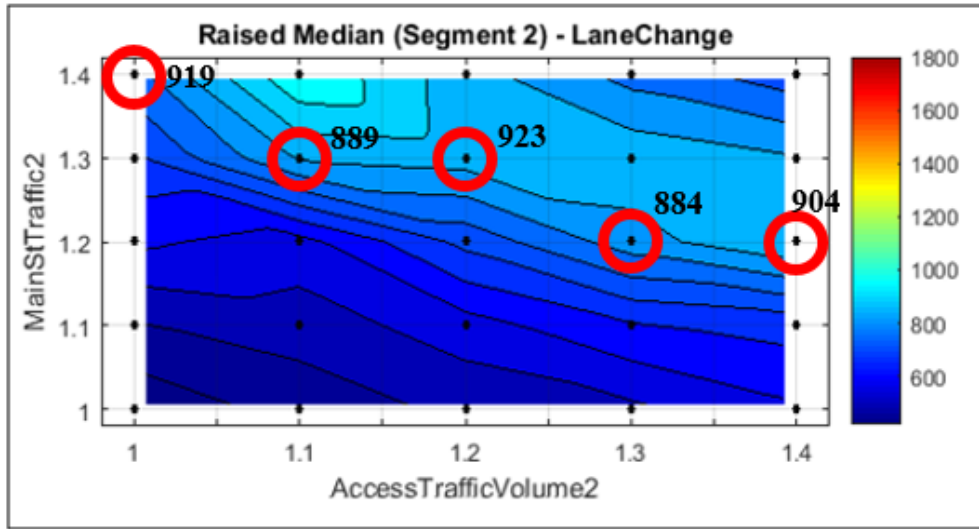
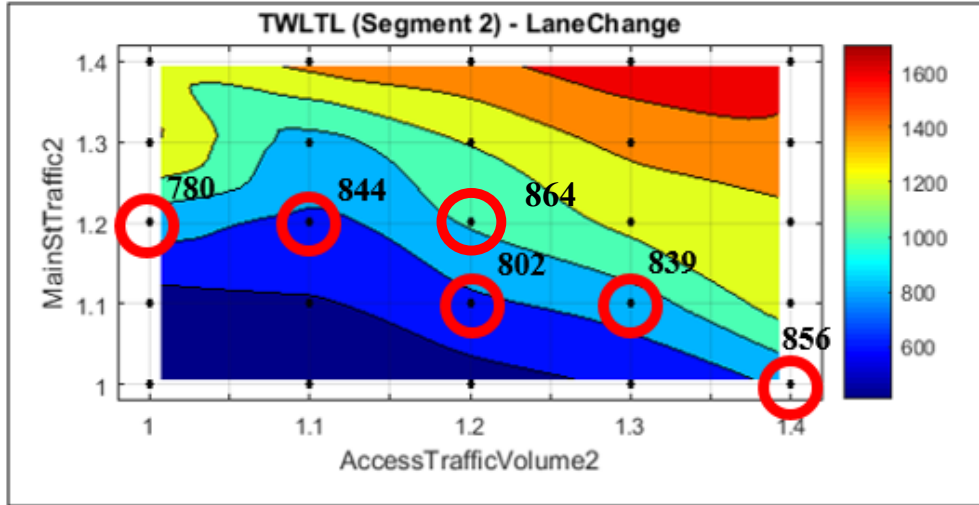
Figure D-1: Threshold volume analysis results for rear-end conflicts

## D.2 Lane-change Conflicts

Figure D-2 shows the results of the threshold traffic volume analysis for lane-change conflicts of TWLTL and raised medians. With the threshold of lane-change conflicts in Segment 2 being set to approximately 1,000, traffic volumes on or near the cyan-colored contour were determined and they were found to be approximately 780 to 864 vehicles per hour per lane. With the raised median, traffic volumes on or near the cyan-colored contour were determined to be 884 to 923 vehicles per hour per lane. The raised median can accommodate 20 to 143 vehicles per hour per lane more to reach the same level of lane-change conflicts for the TWLTL median.

Knowing that the study segments have four lanes (a total of the number of lanes in both directions), the threshold traffic volume to convert a TWLTL median to a raised median would be approximately 3,120 to 3,460 vehicles per hour ( $780 \times 4 = 3,120$  and  $864 \times 4 = 3,456$  as shown in Figure D-2). Since the percentage of the current PM peak hourly volume against AADT for Main Street in the study area is about 9 percent (this percentage was estimated using the traffic volume used in the VISSIM model provided by UDOT and AADT data available from UDOT for year 2014), the threshold AADT for considering the conversion of a TWLTL median to a raised median would be approximately 34,700 to 38,400 veh/day for the four lanes in Segment 2 (two lanes in each direction). A raised median may begin to have a similar level of lane-change conflicts as the one for TWLTL when the hourly volume becomes approximately 3,536 to 3,692 vehicles per hour ( $884 \times 4 = 3,536$  and  $923 \times 4 = 3,692$  as shown in Figure D-2). With these hourly values, the AADT where a raised median might begin to have an increase in the number of lane-change conflicts similar to the TWLTL median would be approximately 39,300 to 41,000 veh/day for the four lanes on Segment 2 of this study section.





**Figure D-2: Threshold volume analysis results for lane-change conflicts**

### D.3 Total Conflicts

Figure D-3 shows the results of the threshold traffic volume analysis for total conflicts of TWLTL and raised medians. With the threshold of total conflicts in Segment 2 being set to approximately 6,000, traffic volumes on or near the cyan-colored contour were determined and they were found to be approximately 780 to 864 vehicles per hour per lane. With the raised median, traffic volumes on or near the cyan-colored contour were determined to be 864 to 919

vehicles per hour per lane. The raised median can accommodate 0 to 139 vehicles per hour per lane more to reach the same level of total conflicts for the TWLTL median.

Knowing that the study segments have four lanes (a total of the number of lanes in both directions), the threshold traffic volume to convert a TWLTL median to a raised median would be approximately 3,120 to 3,460 vehicles per hour ( $780 \times 4 = 3,120$  and  $864 \times 4 = 3,456$  as shown in Figure D-3). Since the percentage of the current PM peak hourly volume against AADT for Main Street in the study area is about 9 percent (this percentage was estimated using the traffic volume used in the VISSIM model provided by UDOT and AADT data available from UDOT for year 2014), the threshold AADT for considering the conversion of a TWLTL median to a raised median would be approximately 34,700 to 38,400 veh/day for the four lanes in Segment 2 (two lanes in each direction). A raised median may begin to have a similar level of total conflicts as the one for TWLTL when the hourly volume becomes approximately 3,456 to 3,676 vehicles per hour ( $864 \times 4 = 3,456$  and  $919 \times 4 = 3,676$  as shown in Figure D-3). With these hourly values, the AADT where a raised median might begin to have an increase in the number of total conflicts similar to the TWLTL median would be approximately 38,400 to 40,800 veh/day for the four lanes on Segment 2 of this study section.

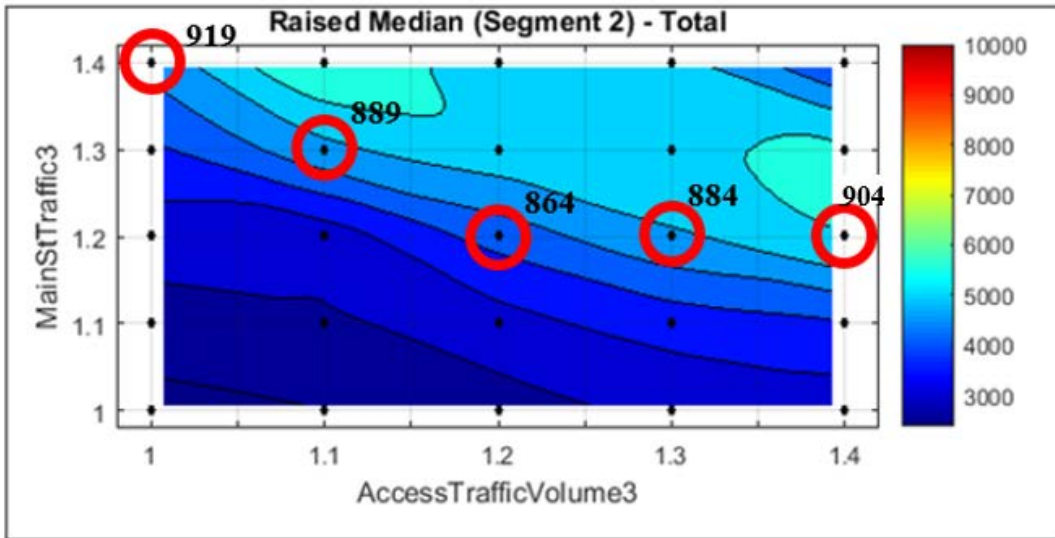
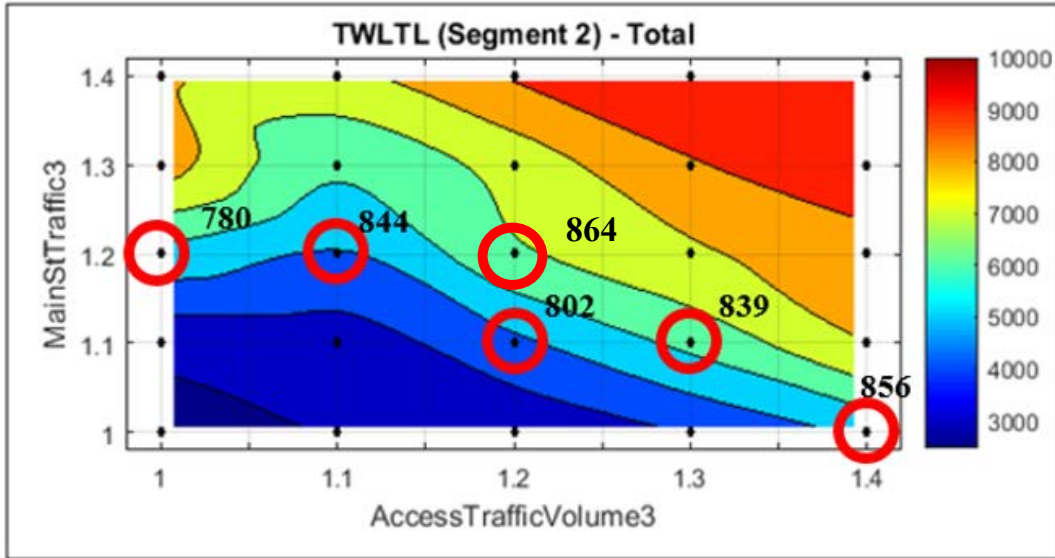


Figure D-3: Threshold volume analysis results for total conflicts